



## **User Guide**

**Battery Management Unit Reference Design Kit  
(EVKT-BMU16S, EVKT-BMU16SNL, EVKT-BMU10S,  
EVKT-BMU10SNL, and EVKT-BMU16S-G1)**

## Table of Contents

Overview .....	4
Introduction .....	4
Evaluation Kits .....	5
Kit Contents .....	5
EVKT-BMU16S.....	5
EVKT-BMU16SNL .....	5
EVKT-BMU14S.....	5
EVKT-BMU10S.....	6
EVKT-BMU10SNL .....	6
EVKT-BMU16S G1 (Next Generation FG) .....	6
EVKT-BMU14S G1 (Next Generation FG) .....	6
Features and Benefits .....	7
Kit Specifications .....	8
Hardware Limitations Affecting Testing and Usage .....	8
EVKT-BMU16S, EVKT-BMU16S-G1, EVKT-BMU16SNL Limitations.....	8
EVKT-BMU10S, EVKT-BMU10SNL, EVKT-BMU14S, EVKT-BMU14-G1 Limitations .....	8
Section 1. Hardware Specifications.....	9
1.1 Personal Computer Requirements.....	9
1.2 EVBMU1xx-R-01A Specifications .....	9
1.3 EVBMU1xx-R-01A Schematics.....	10
1.4 EVBMU1xx-R-01A Bill of Materials .....	13
1.5 EVBMU1xx-R-01A PCB Layout .....	17
1.6 EVKT-BMU1xx Specifications.....	18
Section 2. Software Requirements.....	19
2.1 Software Installation Procedure .....	19
Section 3. Evaluation Kit Test Set-Up .....	20
3.1 Hardware Set-Up.....	20
3.2 Powering Up the EVB .....	20
3.3 Opening the EVB GUI and Connecting to the Board.....	21

- 3.4 GUI Preferences..... 26
- 3.5 Quick Configuration of the EVB ..... 27
- 3.6 Expert Mode Configuration ..... 29
- 3.7 Read and Write Configurations..... 34
- 3.8 Import and Export Configurations ..... 35
- 3.9 Monitoring and Recording..... 37
- 3.10 Plotting ..... 40
- 3.11 Learnings..... 40
- 3.12 LED Settings..... 41
- 3.13 Customer Password ..... 42
- 3.14 Virtual Fuel Gauge..... 43
- 3.15 Others..... 46
- Section 4. EVBMU1xx-R-00A as a BMS Using the MP2797/MP2791 ..... 49
  - 4.1 Features ..... 49
- Section 5. UART Protocol..... 62
  - 5.1 UART Protocol..... 62
  - 5.2 UART to I<sup>2</sup>C..... 64
  - 5.3 Register Map ..... 64

## Overview

### Introduction

The EVKT-BMU1xx is an evaluation kit for the EVBMU1xx-R-01A, a reference design board for a 7-cell to 16-cell in series battery management unit.

This board uses the MP279x ICs, a robust family of battery management analog front-ends (AFEs) that provide a complete AFE monitoring and protection solution. The MP279x supports up to 16 cells in series, and provides two separate analog-to-digital converters (ADCs) for synchronous voltage and current measurements. The high-side MOSFET (HS-FET) driver and robust HW protection functions come with configurable thresholds. Protections include over-current protection (OCP), short-circuit protection (SCP), battery and cell over-voltage protection (OVP), battery and cell under-voltage protection (UVP), over-temperature protection (OTP), and under-temperature protection (UTP). The MP279x also integrates internal balancing FETs to equalize mismatched cells while offering the option to control external FETs for a higher balancing current.

The board also features the MPF4279x, a standalone battery fuel gauge (FG) IC that performs state-of-charge (SoC), time-to-full, time-to-empty, and unavailable energy estimation using a custom battery model obtained through exhaustive characterization and voltage, current, and temperature readings. This solution is fast, simple, and easy to configure through the graphic user interface (GUI). Figure 1 shows the EVKT-BMU1xx block diagram.

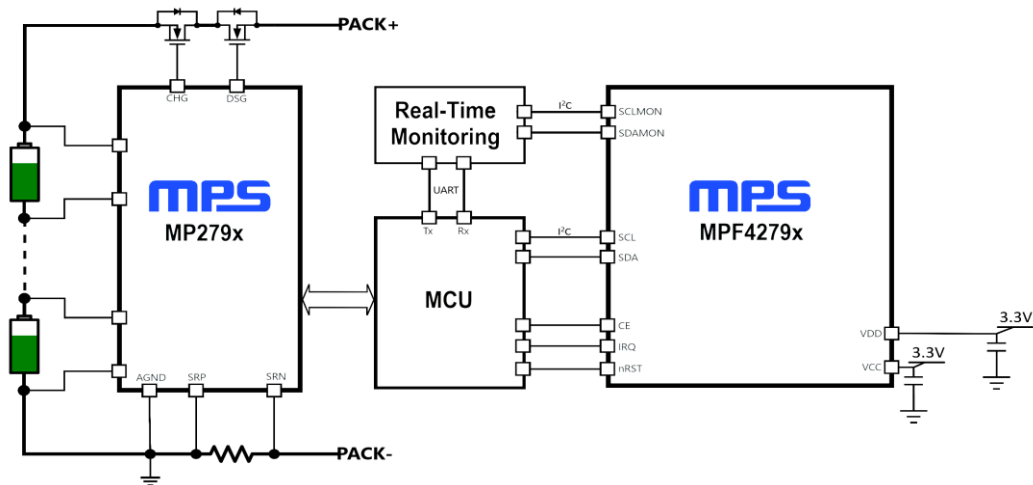

Figure 1: EVKT-BMU1xx Block Diagram Design

Each EVKT-BMU1xx evaluation board offers a different combination of the MP279x AFE and the MPF4279x fuel gauge. See the Evaluation Kits section on page 5 for more details.

**Evaluation Kits**

Reference Design	MPF4279x Part Number	MPF4279x Short Description	MP279x Part Number	MP279x Short Description
EVBMU16S-R-01A	MPF42790	2-Cell to 16-Cell FG with Level LEDs	MP2797	7-Cell to 16-Cell BMS with I <sup>2</sup> C
EVBMU16SNL-R-01A	MPF42792	2-Cell to 16-Cell FG	MP2797	7-Cell to 16-Cell BMS with I <sup>2</sup> C
EVBMU14S-R-01A	MPF42790	2-Cell to 14-Cell FG with Level LEDs	MP2791	7-Cell to 14-Cell BMS with I <sup>2</sup> C
EVBMU10S-R-01A	MPF42795	2-Cell to 10-Cell FG with Level LEDs	MP2791	7-Cell to 14-Cell BMS with I <sup>2</sup> C
EVBMU10SNL-R-01A	MPF42797	2-Cell to 10-Cell FG	MP2791	7-Cell to 14-Cell BMS with I <sup>2</sup> C
EVBMU16S-G1-R-01A	MPF42791	Next Generation 2-Cell to 16-Cell FG with Level LEDs	MP2797	7-Cell to 16-Cell BMS with I <sup>2</sup> C
EVBMU14S-G1-R-01A	MPF42791	Next Generation 2-Cell to 14-Cell FG with Level LEDs	MP2791	7-Cell to 14-Cell BMS with I <sup>2</sup> C

**Kit Contents**
***EVKT-BMU16S***

Items included with the kit (items below can be ordered separately):

#	Part Number	Item	Quantity
1	EVBMU16S-R-01A	MP2797DFP-0001-T and MPF42790DRT-0B-0001 reference design and evaluation board	1
2	EVKT-USB_RS232/I2C-01	USB to RS232 / I <sup>2</sup> C adapter	1

***EVKT-BMU16SNL***

Items included with the kit (items can also be ordered separately):

#	Part Number	Item	Quantity
1	EVBMU16SNL-R-01A	MP2797DFP-0001-T and MPF42792DRT-0B-0001 reference design and evaluation board	1
2	EVKT-USB_RS232/I2C-01	USB to RS232 / I <sup>2</sup> C adapter	1

***EVKT-BMU14S***

Items included with the kit (items can also be ordered separately):

#	Part Number	Item	Quantity
1	EVBMU14S-R-01A	MP2791DFP-0001-T and MPF42790DRT-0B-0001 reference design and evaluation board	1
2	EVKT-USB_RS232/I2C-01	USB to RS232 / I <sup>2</sup> C adapter	1

**EVKT-BMU10S**

Items included with the kit (items can also be ordered separately):

#	Part Number	Item	Quantity
1	EVBMU10S-R-01A	MP2791DFP-0001-T and MPF42795DRT-0B-0001 reference design and evaluation board	1
2	EVKT-USB_RS232/I2C-01	USB to RS232 / I <sup>2</sup> C adapter	1

**EVKT-BMU10SNL**

Items included with the kit (items can also be ordered separately):

#	Part Number	Item	Quantity
1	EVBMU10SNL-R-01A	MP2791DFP-0001-T and MPF42797DRT-0B-0001 reference design and evaluation board	1
2	EVKT-USB_RS232/I2C-01	USB to RS232 / I <sup>2</sup> C adapter	1

**EVKT-BMU16S G1 (Next Generation FG)**

Items included with the kit (items can also be ordered separately):

#	Part Number	Item	Quantity
1	EVBMU16S-G1-R-01A	MP2797DFP-0001-T and MPF42791DRT-0B-0001 reference design and evaluation board	1
2	EVKT-USB_RS232/I2C-01	USB to RS232 / I <sup>2</sup> C adapter	1

**EVKT-BMU14S G1 (Next Generation FG)**

Items included with the kit (items can also be ordered separately):

#	Part Number	Item	Quantity
1	EVBMU14S-R-01A	MP2791DFP-0001-T and MPF42791DRT-0B-0001 reference design and evaluation board	1
2	EVKT-USB_RS232/I2C-01	USB to RS232 / I <sup>2</sup> C adapter	1

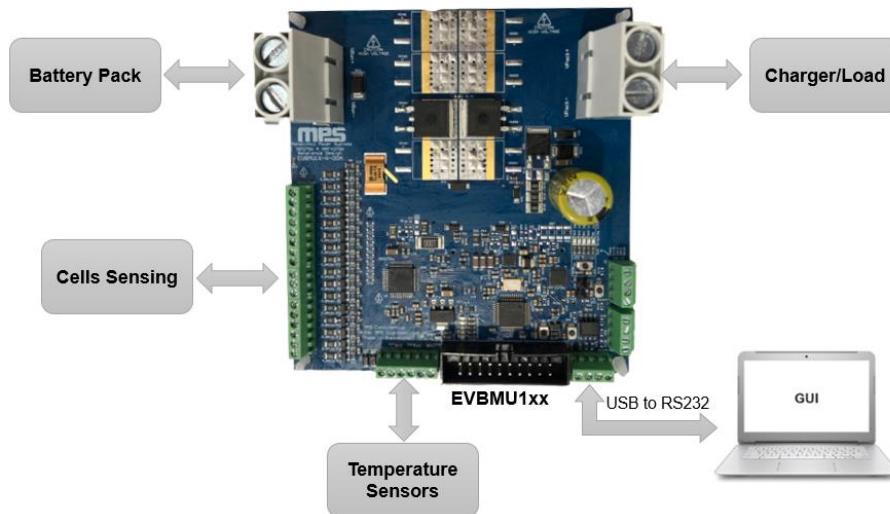
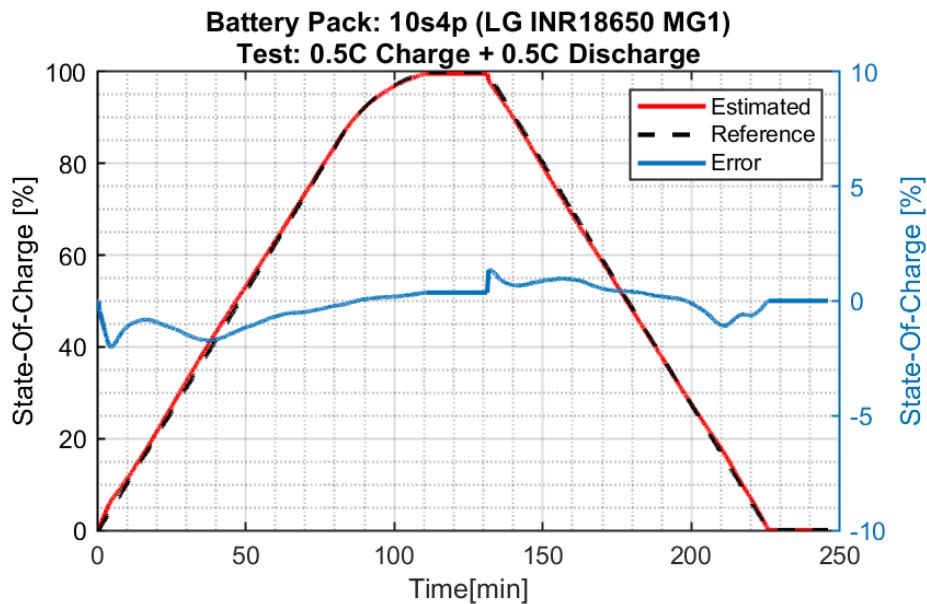

Figure 2: EVBMU1xx-R-01A Evaluation Kit Set-Up

**Features and Benefits**

- High-Side Charge and Discharge (Including Pre-Charge Function) MOSFETs
- 7 Cells, Up to 16 Cells in Series
- True Hardware Protections
- High-Accuracy ADC with the Option of Simultaneous Voltage and Current Measurements
- Configurable Alarm Reactions and Thresholds
  - Configurable Over-Voltage Protection (OVP) and Under-Voltage Protection (UVP)
  - Configurable Charge and Discharge Over-Current Protection (OCP) and Short-Circuit Protection (SCP)
  - Configurable PCB and Battery Over-Temperature Protection (OTP)
  - Self-Functionality Test Options
- Cell-Balancing with Internal MP279x FETs with Option of External FET Balancing for Higher Current
- Open-Wire Detection
- Sleep Mode with Standby Discharge FET for Lower Current Consumption with Automatic Wake-Up when a Load/Charger Is Detected
- Load/Charger Detection Option in Safe Mode
- Accurate Battery Pack State-Of-Charge (SoC) Estimation (see Figure 3)
- Simple Configurations through MPS’s GUI
- Supports any Lithium-Based Cell Type Using a Dedicated Battery Cell Model



**Figure 3: EVBMU16S-R-01A Performance Example**

**Kit Specifications <sup>(1)</sup>**

Features	Specifications
Max series cell support	EVKT-BMU16Sxx: 16 cells in series EVKT-BMU14Sxx: 14 cells in series EVKT-BMU10Sxx: 10 cells in series
Battery pack voltage range	EVKT-BMU16Sxx: 18V to 70.4V EVKT-BMU14Sxx: 18V to 65.8V EVKT-BMU10Sxx: 18V to 44V
Cell voltage range	Up to 4.5V (configurable cell UV and OV thresholds)
Charge current range	0A to 130.07A (configurable charge OC threshold) <sup>(1)</sup>
Discharge current range	0A to 130.07A (configurable discharge OC threshold) <sup>(1)</sup>
Total high-side protection resistance (connectors + PCB traces + 1 parallel FETs)	4mΩ to 5mΩ
Operating systems supported	Windows 7 or later
System requirements	Minimum 350MB free
EVB size (LxW)	9.65cmx9.74cm

**Note:**

1) It is not recommended to exceed 50A of continuous current for the 4 parallel FET configuration. However, higher peak currents are supported.

**Hardware Limitations Affecting Testing and Usage**

The EVBMU1xx-R-01A family is for demonstration only, and should never be used in a production environment.

***EVKT-BMU16S, EVKT-BMU16S-G1, and EVKT-BMU16SNL Limitations***

The EVKT-BMU16x uses an engineering sample of the MP2797. The microcontroller (MCU) and GUI are designed to provide a simplified experience to overcome some of the sample limitations. The user should review the MP2797 datasheet and related application note to be aware of such limitations. Contact and MPS FAE for the application note.

To ensure a robust set-up, excellent performance, and optimal BOM, note the changes related to the MP2797's engineering pre-sample. Changes that deviate from what is suggested in this guide are not advised; before doing so, contact an MPS FAE.

***EVKT-BMU10S, EVKT-BMU10SNL, EVKT-BMU14S, and EVKT-BMU14-G1 Limitations***

The EVKT-BMU10x and EVKT-BMU14S use an engineering sample of the MP2791. The microcontroller (MCU) and GUI are designed to provide a simplified experience to overcome some of the sample limitations. The user should review the MP2791 datasheet and related application note to be aware of such limitations. Contact and MPS FAE for the application note.

To ensure a robust set-up, excellent performance, and optimal BOM, note the changes related to the MP2791's engineering pre-sample. Changes that deviate from what is suggested in this guide are not advised; before doing so, contact an MPS FAE.



## Section 1. Hardware Specifications

### 1.1 Personal Computer Requirements

The following minimum conditions must be met to use the EVKT-BMU1xx:

- Operating System of Windows 7 or later
- Net Framework 4.6.1
- PC with a minimum of one available USB port
- At least 350MB of free space

### 1.2 EVBMU1xx-R-01A Specifications

The EVBMU1xx-R-01A is a reference design and evaluation board for the MP279x and the MPF4279x.

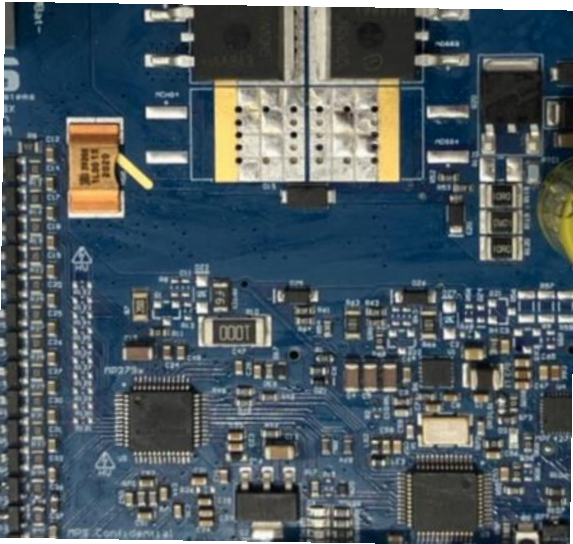

Figure 4: EVBMU1xx-R-01A Evaluation Board

Feature	Specifications
Battery pack voltage	18V to 70.4V (16-cell battery)
	18V to 65.8V (14-cell battery)
	18V to 44V (10-cell battery)
Charger voltage	18V to 72V (16-cell battery)
	18V to 67.8V (14-cell battery)
	18V to 46V (10-cell battery)
Parallel protection N-channel MOSFETs	1 to 4
EVB size (LxW)	9cmx9.7cm

### 1.3 EVBMU1xx-R-01A Schematic

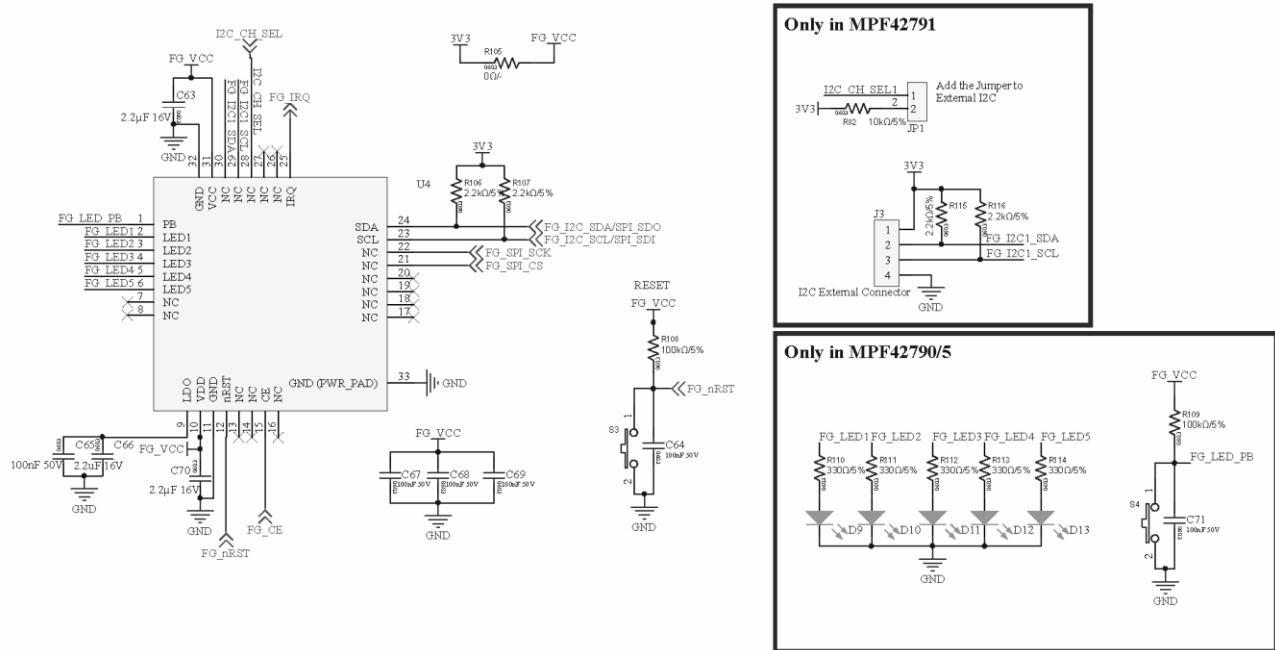

Figure 5: FG MPF4279x Schematic

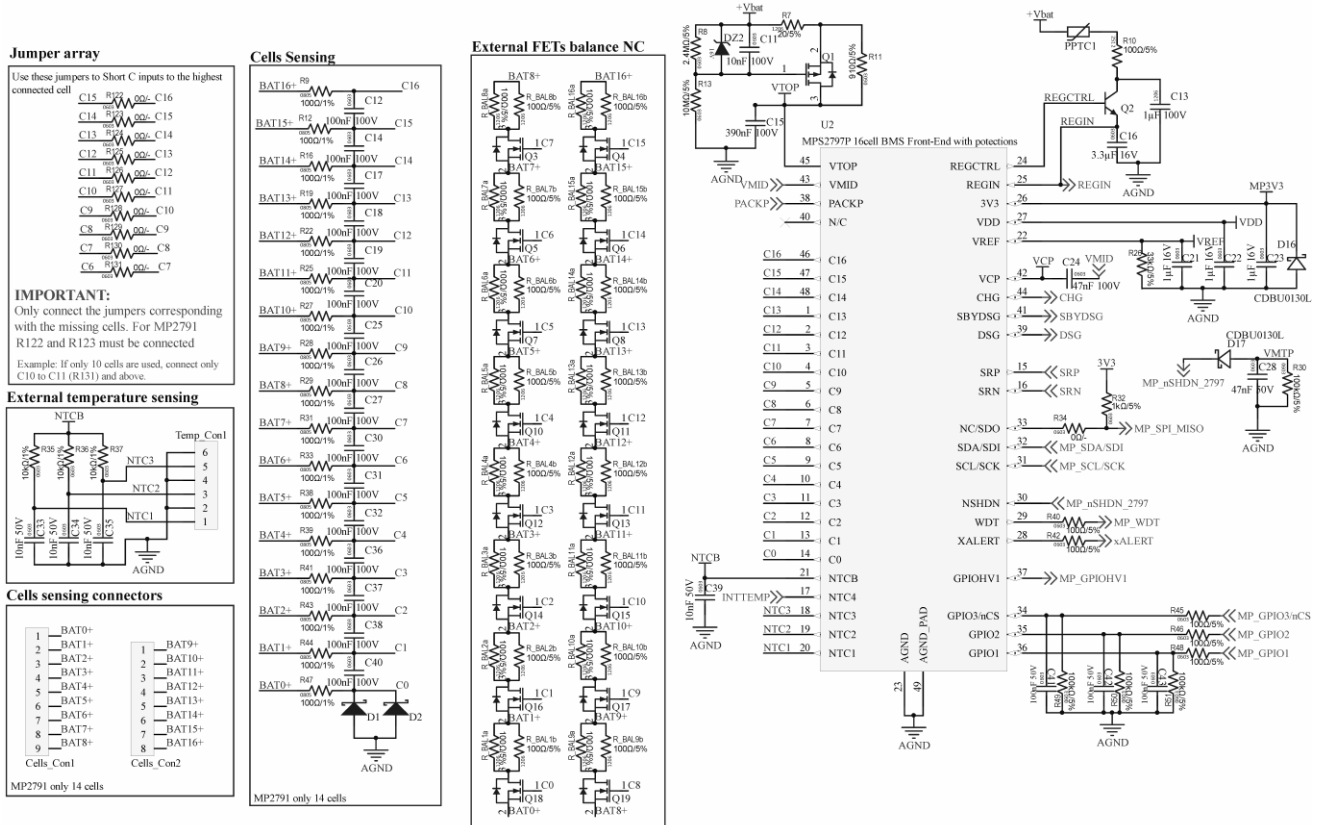

Figure 6: BMS MP279x Schematic

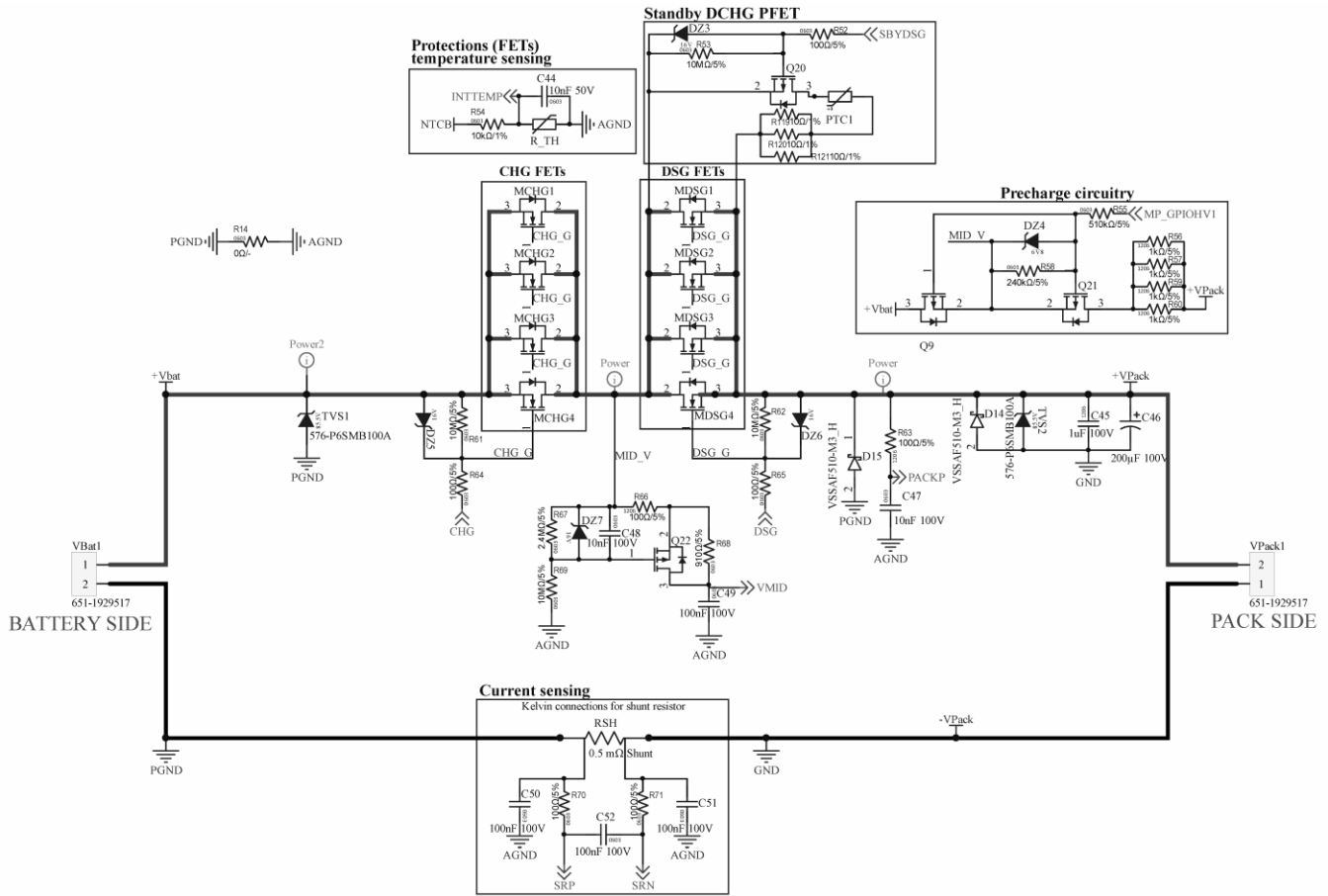

Figure 7: BMS Protections Schematic

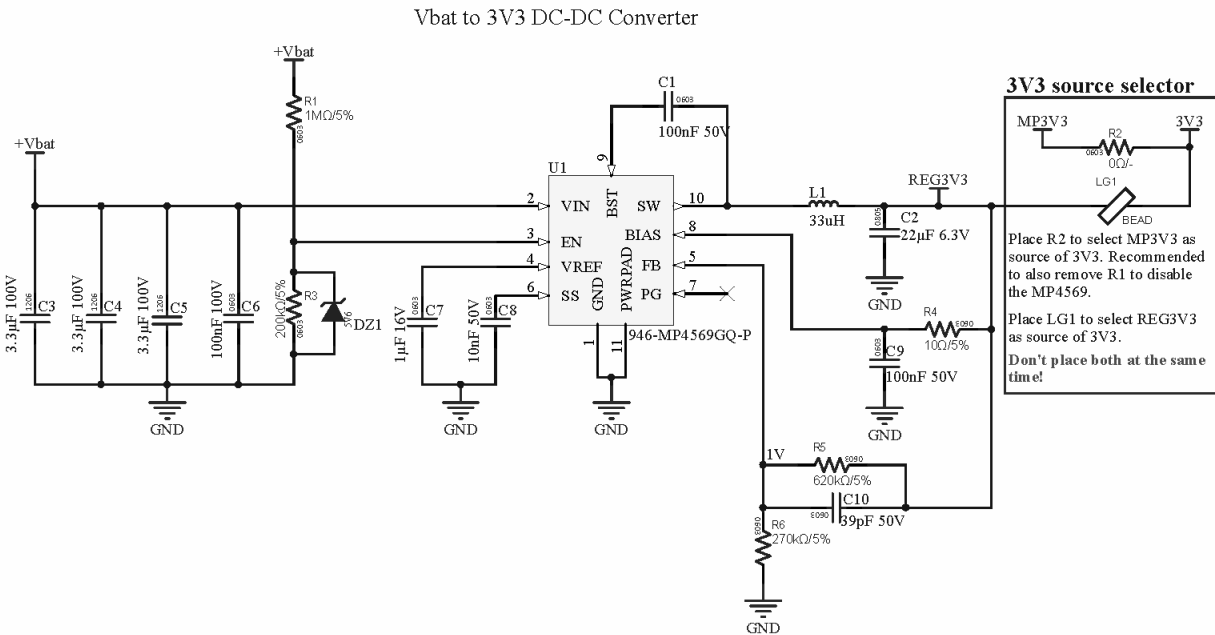

Figure 8: Power Supplies Schematic

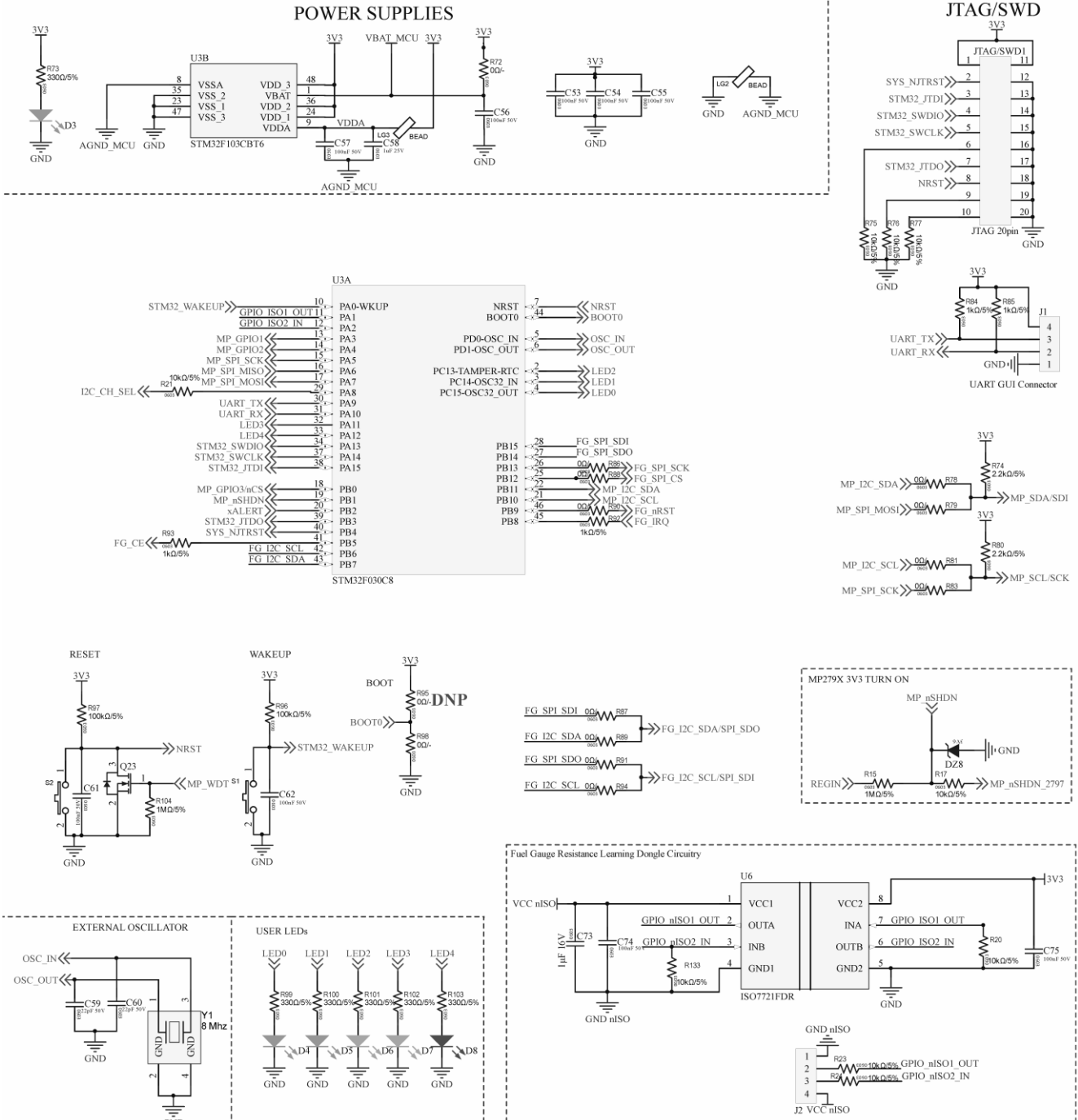

Figure 9: MCU STM32F030C8

**1.4 EVBMU1xx-R-01A Bill of Materials**

Qty	Ref	Value	Description	Package	Manufacturer	Manufacturer PN
21	C1, C9, C29, C41, C42, C43, C53, C54, C55, C56, C57, C61, C62, C64, C65, C67, C68, C69, C71, C74, C75	100nF	Ceramic capacitor, 50V, X7R	0603	AVX	06031C104KAT2A
1	C2	22 $\mu$ F	Ceramic capacitor, 6.3V, X5R	0805	Taiyo Yuden	JMK212BJ226MG-T
3	C3, C4, C5	3.3 $\mu$ F	Ceramic capacitor, 100V, X7S	1206	TDK	CGA5L3X7S2A335M160AB
21	C6, C12, C14, C17, C18, C19, C20, C25, C26, C27, C30, C31, C32, C36, C37, C38, C40, C49, C50, C51, C52	100nF	Ceramic capacitor, 100V, X7R	0603	AVX	06031C104KAT2A
5	C7, C21, C22, C23, C73	1 $\mu$ F	Ceramic capacitor, 16V, X7R	0603	Murata	GCJ188R71E105KA01D
6	C8, C33, C34, C35, C39, C44	10nF	Ceramic capacitor, 50V, X7R	0603	Yageo	AC0603KRX7R0BB103
1	C10	39pF	Ceramic capacitor, 50V, C0G	0603	AVX	06035A390FAT2A
3	C11, C47, C48	10nF	Ceramic capacitor, 100V, X7R	0603	Yageo	AC0603KRX7R0BB103
2	C13, C45	1 $\mu$ F	Ceramic capacitor, 100V, X7R	1206	Taiyo Yuden	HMK316BJ105KL-T
1	C15	390nF	Ceramic capacitor, 100V, X7R	1206	Kemet	C1206C394K1RAC TU
1	C16	3.3 $\mu$ F	Ceramic capacitor, 25V, X5R	0603	TDK	C1608X5R1E335K080AC
1	C24	47nF	Ceramic capacitor, 100V, X7R	0603	Wurth	885012206118
1	C28	47nF	Ceramic capacitor, 50V, X7R	0603	Wurth	885012206118
1	C46	200 $\mu$ F	Capacitor, 100V, 200 $\mu$ F, 12.5 x 20	0603	United Chemi-Con	EGXF101ELL201MK25S
1	C58	1 $\mu$ F	Ceramic capacitor, 25V, X5R	0603	Taiyo Yuden	TMK107B7105KA-T
2	C59, C60	22pF	Ceramic capacitor, 50V, NPO	0603	Kemet	C0603C220J1GACT U
3	C63, C66, C70	2.2 $\mu$ F	Ceramic capacitor, 16V, X7S	0603	Taiyo Yuden	EMK107BJ225MA-T
1	Cells_Con1	9-pin	Terminal block connector, 2.54mm, 9P	0.5mmx 0.5mm	Phoenix Contact	1725724
1	Cells_Con2	8-pin	2.54mm terminal block, 8P	0.5mmx 0.5mm	Phoenix Contact	1725711
1	D1	3.3V, 500mW	Zener diode, 3.3V, 500mW	SOD-123	onsemi	MMSZ4684T1G

8	D3, D4, D5, D9, D10, D11, D12, D13	Green	Green LED	0603	RoyalOhm	SML-D12P8WT86C
1	D16	30V, 100mA	Schottky diode, 30V, 100mA	0603	Comchip Technology	CDBU0130L
2	D6, D7	Orange	Orange LED	0603	RoyalOhm	SML-D12D8WT86C
1	D8	Red	Red LED	0603	RoyalOhm	SML-D12U8WT86C
2	D14, D15	100V, 5A	Schottky diode, 100V, 5A	SODFL52 26X100N	Vishay	VSSAF510-M3/H
1	DZ1	5.6V	Zener, 5.6V	SOD-523	Diodes, Inc.	BZT585B5V6T-7
5	DZ2, DZ3, DZ5, DZ6, DZ7	16V	Zener diode, 500mW, 16V	SOD-123	Diodes, Inc.	BZT52C16
1	DZ8	3.6V	Zener diode, 3.6V	SOD-523	onsemi	MM5Z3V6T1G
2	J1, J2	4-pin	2.54mm terminal block, 4P	Header	Phoenix Contact	1725672
1	JTAG/SWD1	20-pin	JTAG, 20-pin	JTAG	Molex-	87834-2019
1	L1	33 $\mu$ H	Inductor, 33 $\mu$ H, 570mA, 533m $\Omega$	1210	Taiyo Yuden	CBC3225T330KR
3	LG1, LG2, LG3	60 $\Omega$	Ferrite bead, 60 $\Omega$	0603	Würth	742792602
2	MCHG3, MDSG3	120A, 100V	Transistor MOSFET, N-channel MOSFET, 120A, 100V	TO-263	Infineon	IPB020N10N5ATMA1
1	PPTC1	60V, 50mA	1206 PPTC resettable fuse, 60V/50mA	1206	Littelfuse	1206L005/60WR
1	PTC1	4.7 $\Omega$	PTC resistor, 4.7 $\Omega$	0805	Murata	PRG21BC4R7MS5RA
2	Q1, Q22	-700mA	Transistor MOSFET, P-channel MOSFET, -700mA, -100V	SOT-23	Diodes, Inc.	ZXMP10A13FTA
1	Q2	6A	NPN, bipolar	SOT-223	Diodes, Inc.	FZT853TA
1	Q23	3.7A	Transistor MOSFET, canal N, 3.7A, 30V	SOT-23	Nexperia	PMV100ENEAR
2	Q9	-3.2A	Transistor MOSFET, canal P, -3.2A, -30V	SOT-23	Nexperia	PMV50EPEAR
1	Q20	6A	Transistor MOSFET, canal P, 6A, -200V	TO-252	onsemi	FQD7P20TM
3	R15, R18, R104	1M $\Omega$	Film resistor, 5%	0603	Panasonic	ERJ-3GEY0R00V
9	R72, R78, R81, R89, R90, R94, R98, R2, R105	0 $\Omega$	Film resistor, 5%	0603	Panasonic	ERJ-3GEYJ105V
1	R3	200k $\Omega$	Film resistor, 5%	0603	Panasonic	ERJ-3GEYJ204V
1	R4	10 $\Omega$	Resistor, 5%	0603	Panasonic	ERJ-3GEYJ100V
1	R5	620k $\Omega$	Film resistor, 5%, 1/10W	0603	Panasonic	ERJ-3EKF6203V
1	R6	270k $\Omega$	Film resistor, 5%, 1/10W	0603	Panasonic	ERJ-3EKF2703V
1	R7	20 $\Omega$	Film resistor, 5%, 1/4W	1206	Panasonic	ERJ-U08J200V
2	R8, R67	2.4M $\Omega$	Resistor, 1%	0603	Panasonic	ERJ-3GEYJ245V

17	R9, R12, R16, R19, R22, R25, R27, R28, R29, R31, R33, R38, R39, R41, R43, R44, R47	100Ω	Resistor, 1%	0805	Yageo	RC0805FR-13100RL
1	R10	100Ω	Resistor, 5%	2512	TE Connectivity	3522100RJT
2	R11, R68	910Ω	Film resistor, 1%	0603	Panasonic	ERJ-3GEYJ911V
5	R13, R53, R61, R62, R69	10MΩ	Resistor, 1%	0603	Panasonic	ERJ-3GEYJ106V
8	R17, R20, R23, R24, R128, R75, R76, R77	10kΩ	Film resistor, 5%	0603	Panasonic	ERJ-3EKF1002V
1	R26	33kΩ	Film resistor, 5%, 1/10W	0603	Panasonic	ERJ-3EKF3302V
8	R30, R49, R50, R51, R96, R97, R108, R109	100kΩ	Film resistor, 1%	0603	Panasonic	ERJ-3EKF1003V
8	R106, R107, R74, R80, R84, R85, R92, R93	1kΩ	Film resistor, 1%	0603	Panasonic	ERJ-3GEYJ102V
4	R35, R36, R37, R54	10kΩ	Film resistor, 1%,	0603	Panasonic	ERJ-3EKF1002V
10	R40, R42, R45, R46, R48, R52, R64, R65, R70, R71	100Ω	Film resistor, 1%	0603	Yageo	RC0603FR-07100RL
2	R63, R66	100Ω	Film resistor, 5%, 1/4W	1206	Bourns	CHP1206-JW-101ELF
11	R73, R99, R100, R101, R102, R103, R110, R111, R112, R113, R114	330Ω	Film resistor, 1%	0603	Bourns	CR0603-FX-3300ELF
3	R118, R119, R120	10Ω	Resistor, 1%	1206	TE Connectivity	CRGP1210F10R
1	R_TH	10kΩ	NTC thermistor	0603	Murata	NCP18XH103F03R B
1	RSH	1mΩ	1Ω, shun	3920	Bourns	CSS2H-3920R-1L00F
4	S1, S2, S3, S4	50mA	Push button with two contacts	SMD	OMRON	B3U-1000P
1	Temp_Con1	2.54mm	2.54mm terminal block, 6P	MPT 0,5/6-2.54	Phoenix Contact	1725698
2	TVS1, TVS2	85.5V	TVS diode, 85.5V	DO-214AA	Littelfuse	P6SMB100A
1	U3	32-bit	MCU, 32-bit ARM, Cortex M0	48-LQFP	STM	STM32F030C8T6
1	U6	2.2V to 5V	Isolator, 2.2V to 5V	D0008B_N	Texas Instruments	ISO7721FDR
2	VBat1, VPack1	2-pin	10.16mm terminal block, 2-pin	MKDSP_10HV/_2-10.16	Phoenix Contact	1929517

1	Y1	8MHz	8MHz crystal ceramic resonator	SMD	Abracon	ABM3B-8.000MHZ-10-1UT
1	U1	MP4569	75V, 0.3A, synchronous step-down converter	QFN-10 (3mmx3mm)	MPS	MP4569GQ-Z
1	U2	MP279x	8-cell to 16-cell battery management system	TQFP-48 (7mmx7mm)	MPS	MP279x-DFP-yyyy
1	U4	MP4279x	2-cell to 16-cell fuel gauge	TQFN-32	MPS	MPF4279x-0B-yyyy



1.5 EVBMU1xx-R-01A PCB Layout

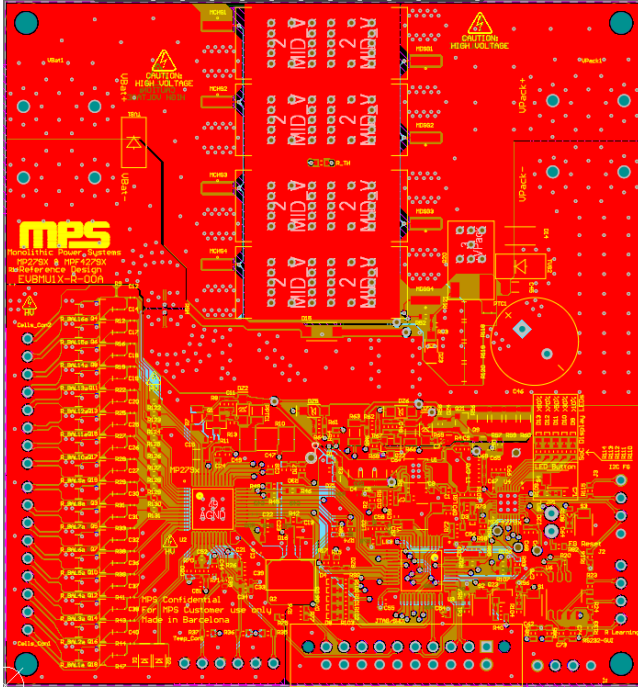

Figure 10: Top Layer

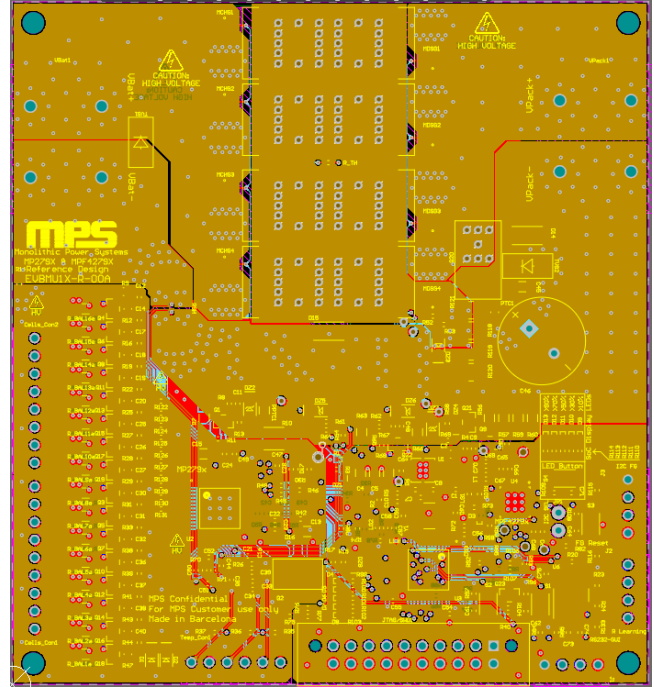

Figure 11: Mid-Layer 1

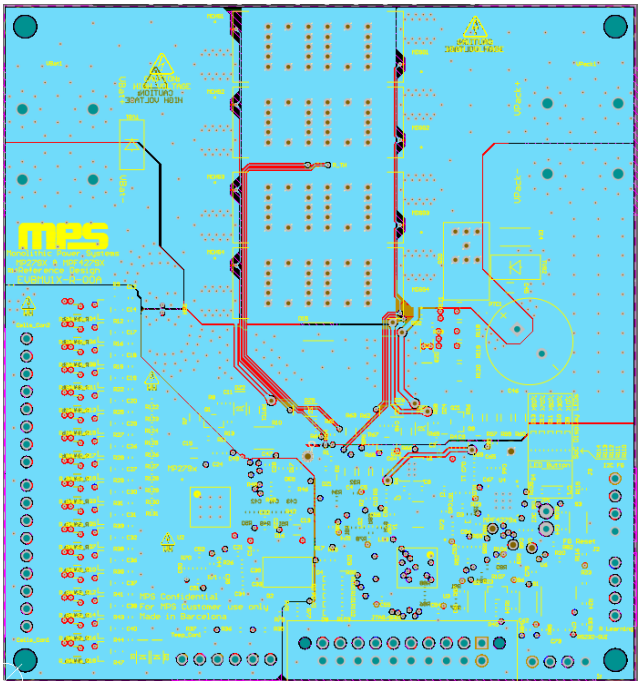

Figure 12: Mid-Layer 2

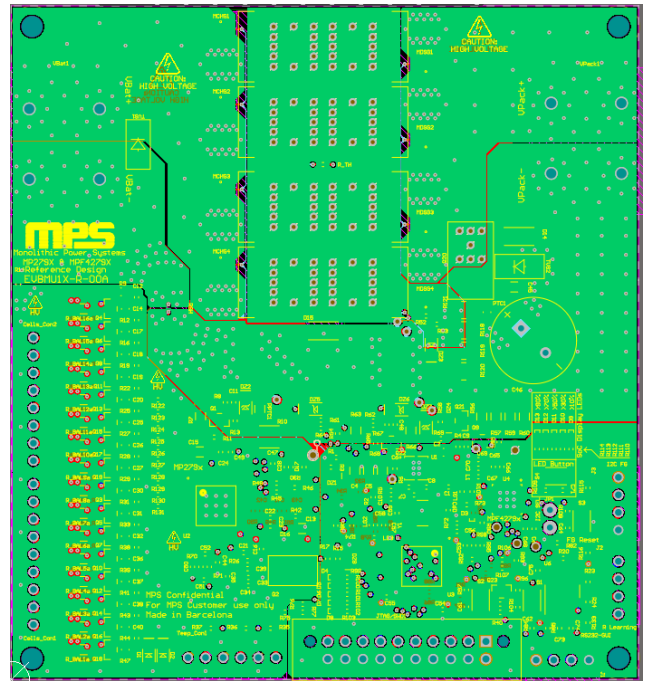

Figure 13: Mid-Layer 3

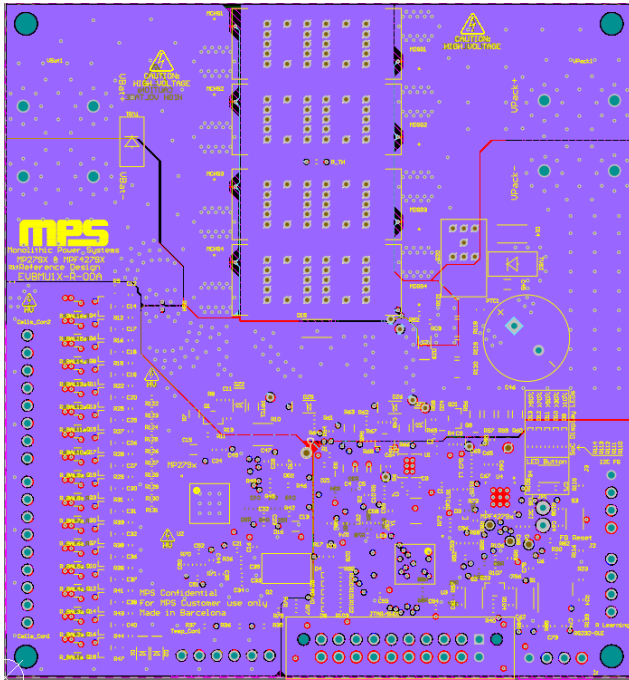

Figure 14: Mid-Layer 4

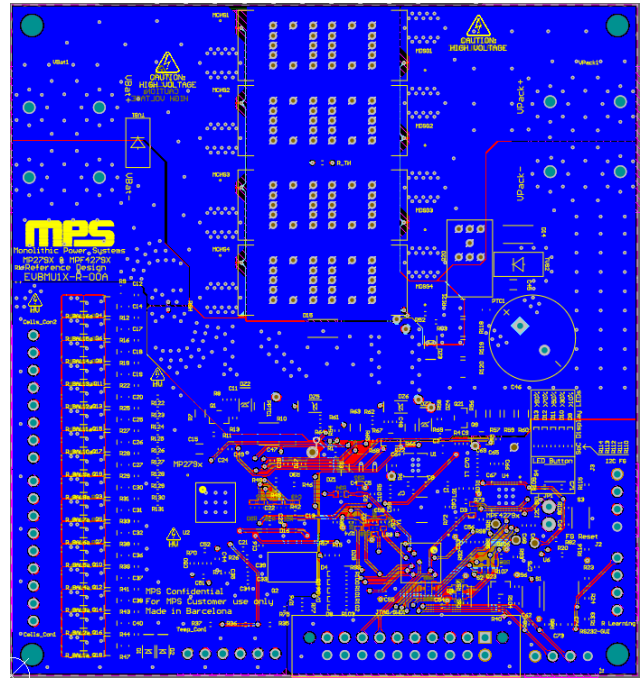

Figure 15: Bottom Layer

### 1.6 EVKT-BMU1xx Specifications

For the EVKT-BMU1xx, the USB to UART cable can be paired with EVKT-BMU1xx so that users can access the GUI, which allows users to easily evaluate the fuel gauge performance (see Figure16).



Figure 16: USB to UART Cable (FT232R-KIT)

## Section 2. Software Requirements

### 2.1 Software Installation Procedure

Configuring occurs through the EVKT-BMU1xx GUI. Follow the instructions below to install the software.

1. Browse the folder containing the thumb drive contents.
2. Double click the “.msi” file to open the set-up guide (see Figure 17).

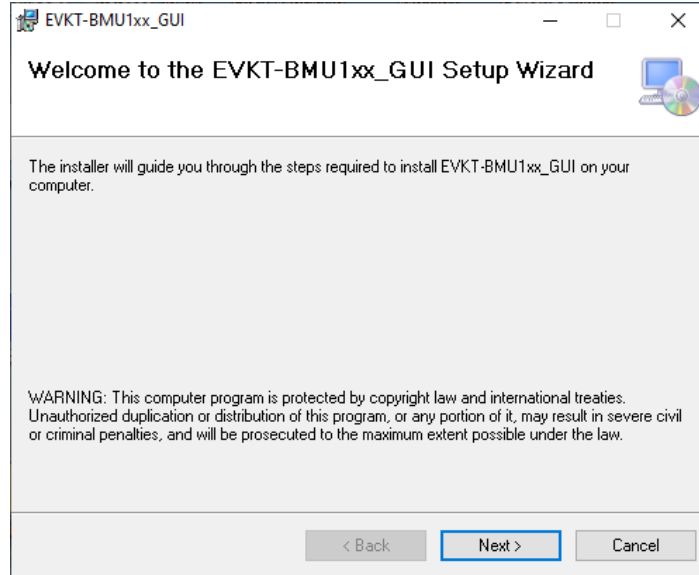

Figure 17: EVKT-BMU1xx GUI Set-Up Guide

3. Follow the prompts in the set-up guide. The installation process may take a few minutes.
4. Wait for the status screen to verify that installation is complete (see Figure 18).

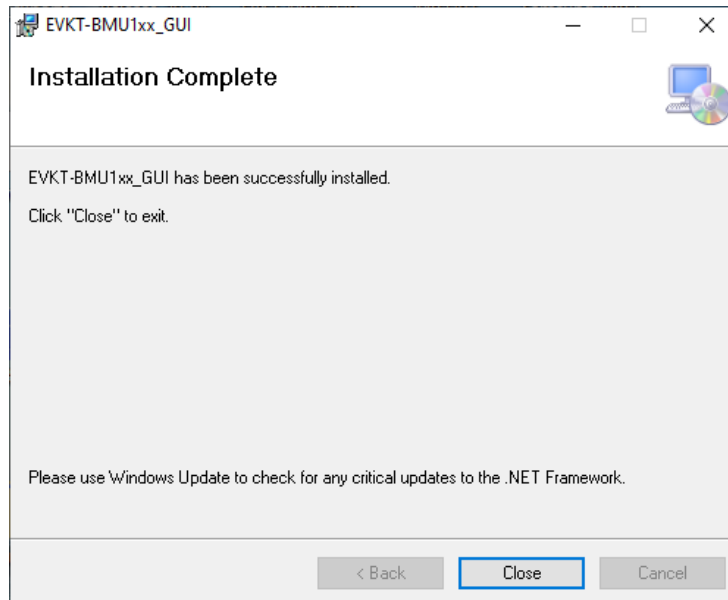

Figure 18: GUI Set-Up Success

## Section 3. Evaluation Kit Test Set-Up

### 3.1 Hardware Set-Up

The hardware must be properly configured prior to use, and the evaluation board connections must be correct. For the best results, refer to Figure 19 and follow the steps below:

1. Connect the cell terminals to the sensing connectors.
2. Connect the battery terminals to:
  - a. Positive (+): VBat+
  - b. Negative (-): VBat-
3. Connect and locate the temperature sensors.
4. Connect the charger or the load terminals to:
  - a. Positive (+): VPack+
  - b. Negative (-): VPack-
5. Locate the proper wires to connect the EVB to the USB to UART cable.
6. Make the TX, RX, and GND connections.
  - a. Connect EVB-TX to the communication interface's RX.
  - b. Connect EVB-RX to the communication interface's TX.
7. Connect the USB cable to the PC.

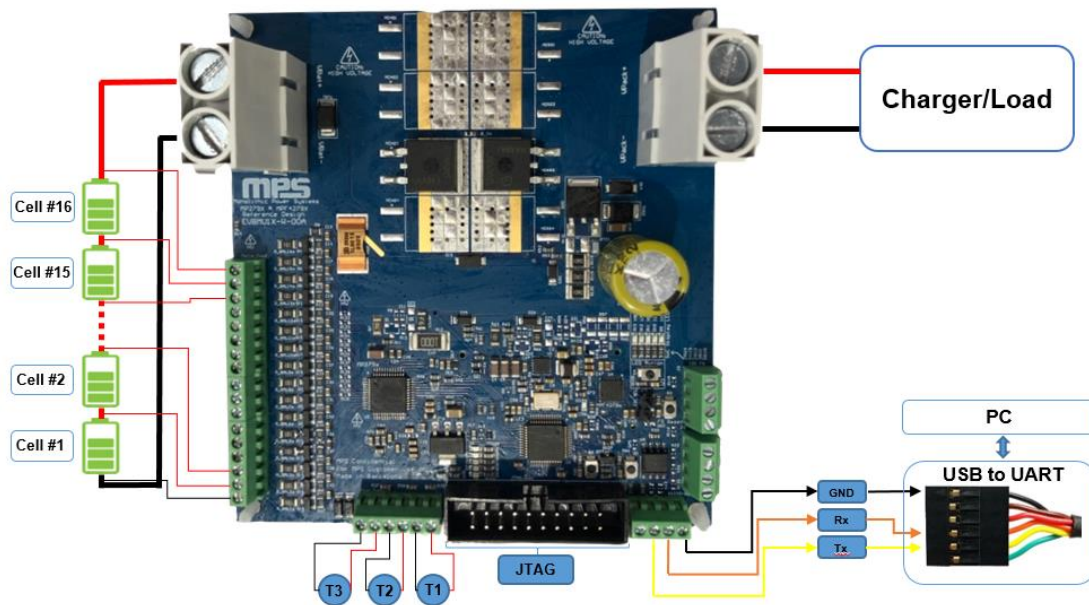

Figure 19: EVB Wire Connection

### 3.2 Powering Up the EVB

1. Connect the cell terminals to the sensing connectors (see Figure 19).
2. Connect the battery terminals to:
  - a. Positive (+): VBat+
  - b. Negative (-): VBat-

If the battery terminals are connected before the cell-sensing terminals, press the S2 button on the evaluation board to reset the MCU, or use the GUI to reset the errors (as well as the BMS).

### 3.3 Opening the EVB GUI and Connecting to the Board

After installing the software and connecting the hardware, follow the steps below to use the GUI software.

1. Open the EVKT-BMU1xx\_GUI software using the computer. A small window should appear on the screen
2. Select the evaluation board in use (see Figure 19 on page 20) The desired BMS and fuel gauge (FG) IC can be selected in a few ways.
  - a. Manually select the EVBMU1xx version in the drop-down menu (see Figure 20 and Figure 21).

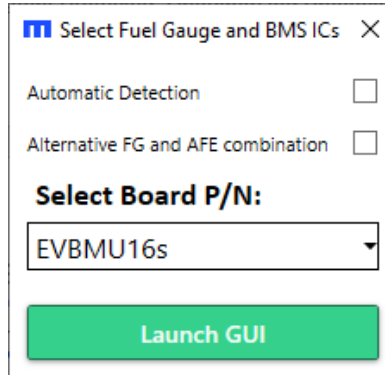

Figure 20: Fuel Gauge and BMS ICs Selection Window 1

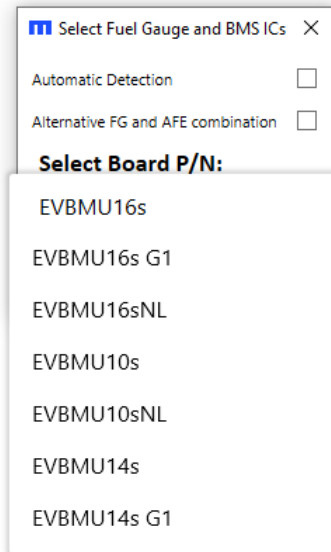

Figure 21: Fuel Gauge and BMS ICs Selection Window 2

- b. Manually select the BMS and FG ICs independently with the drop-down menus (see Figure 22, Figure 23, and Figure 24 on page 22).

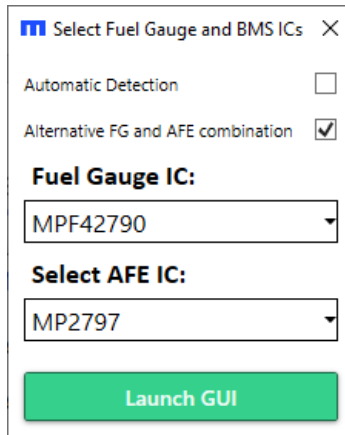

Figure 22: Fuel Gauge and BMS ICs Selection Window 3

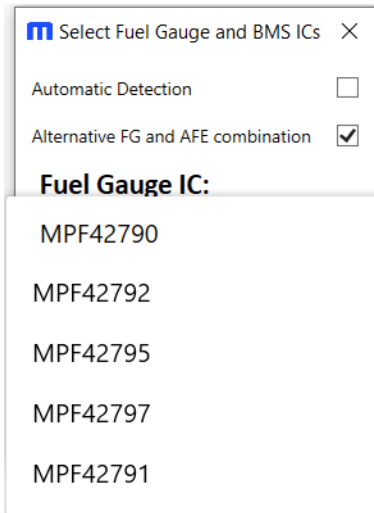

Figure 23: Fuel Gauge and BMS ICs Selection Window 4

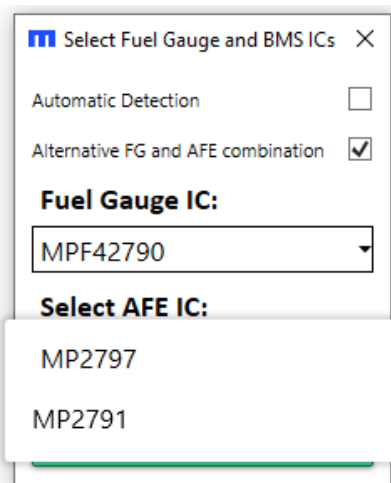

Figure 24: Fuel Gauge and BMS ICs Selection Window 5

- c. Allow the GUI to automatically detect which device is connected. Then select the COM port connected to the evaluation board on the drop-down menu (see Figure 25 and Figure 26 on page 23).

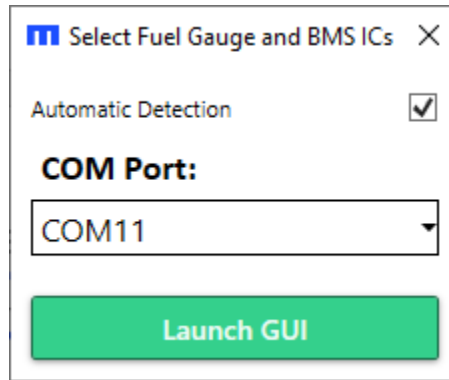

Figure 25: Fuel Gauge and BMS ICs Selection Window 6

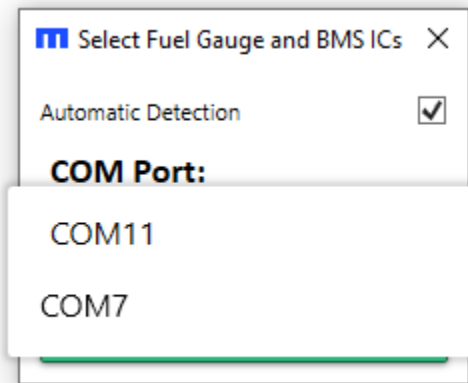

Figure 26: Fuel Gauge and BMS ICs Selection Window 7

3. Launch the GUI using the button on the Fuel Gauge and BMS ICs selection window. The GUI may take a few seconds to load. A small loading window should be available at this time (see Figure 27).



Figure 27: GUI Loading Window

4. The main window should appear (see Figure 28 on page 24).

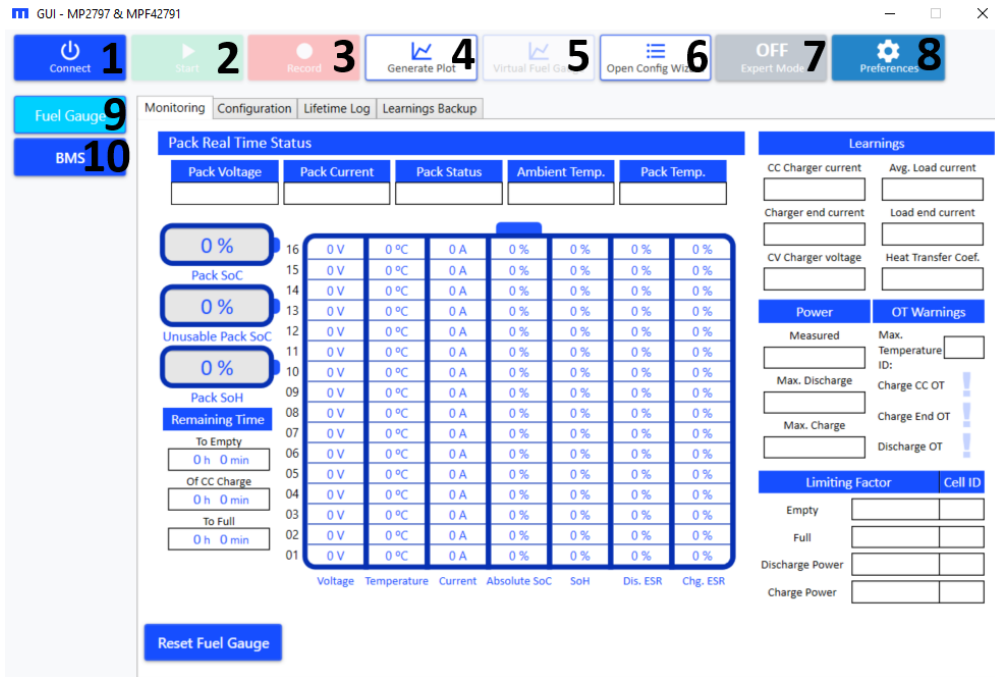

Figure 28: GUI Main Window

- Click “Connect” in the upper bar (denoted as “1” in Figure 28). A window with a drop-down menu should appear.
- Select the device from the drop-down menu, then click “Connect”.

Note that this step can be ignored if automatic detection was used to select the fuel gauge IC. If the PC correctly identified the COM port, the device should be listed in the drop-down menu (see Figure 29).



Figure 29: EVB Connection to the PC



If the device cannot be connected, verify that the evaluation board was connected according to Section 3.1 on page 20, then verify that the device started up according to Section 3.2 on page 20. If the problem persists, check the connections between the evaluation board, UART to USB cable, and PC. Re-plug the USB into computer and restart the GUI.

- When connecting to the board, the GUI reads all evaluation board configuration parameters (for the FG and BMS). During this process, the “Connect” button should change to “Connecting” (see Figure 30). This process may take a few seconds.

Note that during the connection process, the configurations stored on the GUI are overwritten by the connect function. To save the configuration, export all changes before making the device connections (see Section 3.8 on page 35 for more details).



Figure 30: GUI Connecting to the EVB

- Once the connection is complete, the button should show up as “Connected” (see Figure 31 on page 26). Once the mouse cursor moves over this button, it shows as “Disconnect”.



Figure 31: Completed Connection to the EVB

9. Click “Disconnect” to release the COM port.

### 3.4 GUI Preferences

1. Click “Preferences” (denoted as “8” in Figure 28 on page 24). The Preference window should open.
2. Select the directories for the exports (“.csv” monitoring exports, configuration exports, or plots). The export names provide the option to add the date and time to the export files (see Figure 32).

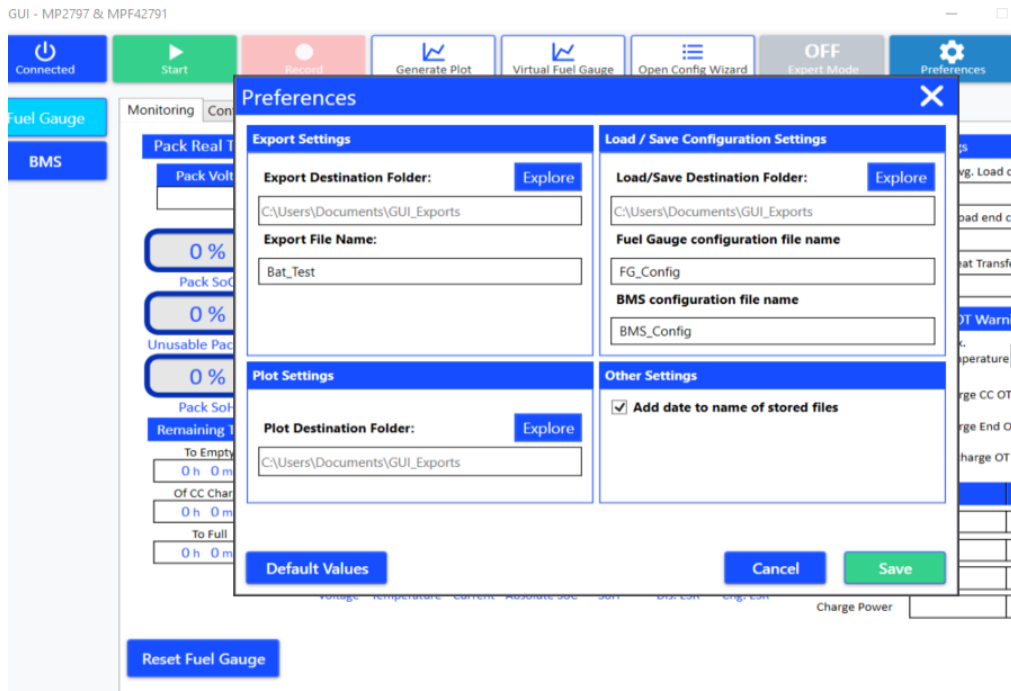

Figure 32: Preferences Window

3. The default values should be displayed on the screen. For example, “user” should target the desktop user that has access the GUI. The default values are used the first time the GUI is opened, or if the user clicks “Default Values”.
4. Once the configurations have been made, click “Save” (see Figure 32 on page 26). The configurations should be saved.

Note that the selected directories must exist; otherwise, the default value is used.

**3.5 Quick Configuration of the Evaluation Board**

5. The GUI is initialized with the default configuration, and it reflects the evaluation board configurations for the connected board.
6. Click “Open Config Wizard” (denoted as “6” in Figure 28 on page 24).
7. The wizard to select the cell profile should open. To use a new profile, click “Select” and use the file explorer to select a valid “.xml” file containing a cell profile (see Figure 33).

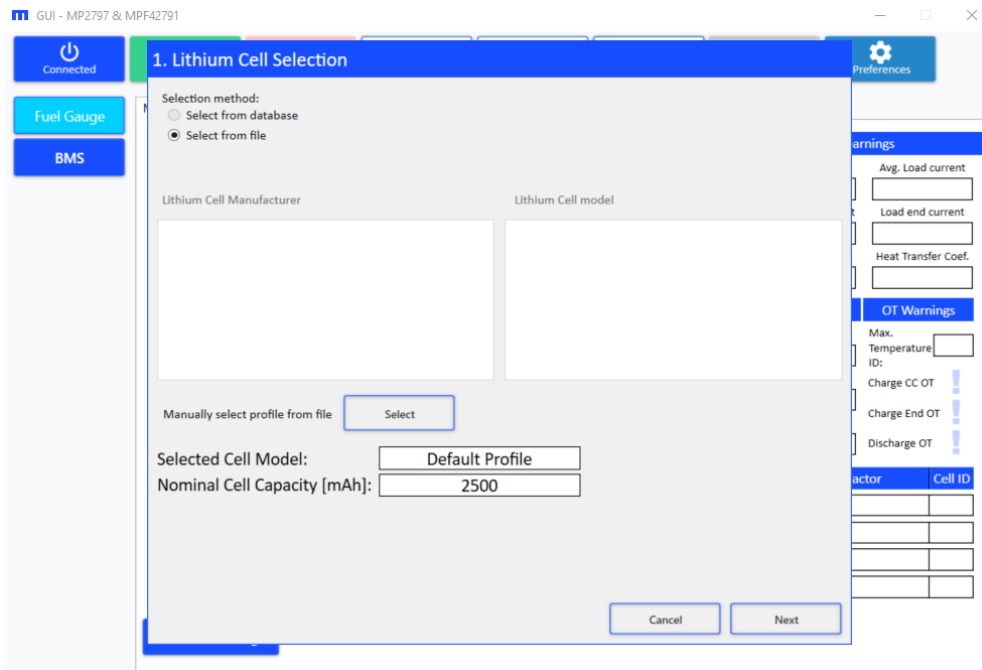

**Figure 33: Configuration Wizard 1 – Cell Profile Selection**

8. Click “Next” after making the cell selection. The Battery Pack Configuration window should open (see Figure 33).
9. Use the Battery Pack Configuration window to select the most relevant parameters for the fuel gauge (denoted in blue) and the BMS protection (denoted in red) (se Figure 34 on page 28).

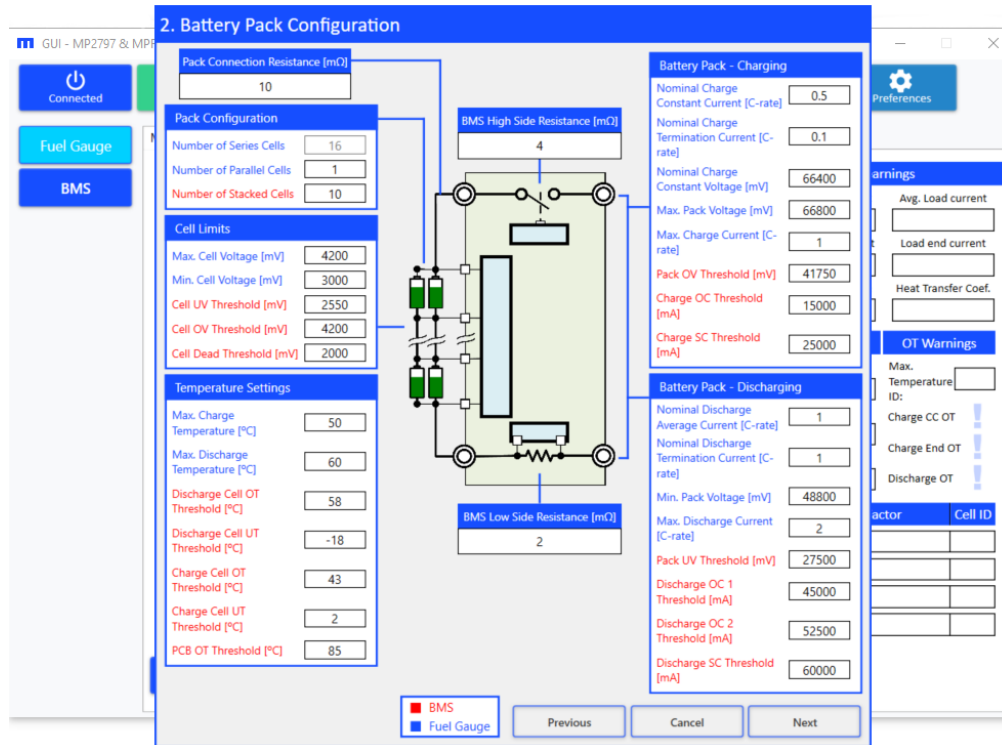

Figure 34: Configuration Wizard 2 – Battery Pack Configuration

10. Place the cursor on top of a register name to display the register’s information (see Figure 35). For more detailed information on the fuel gauge registers, refer to the relevant MPF4279x datasheet.

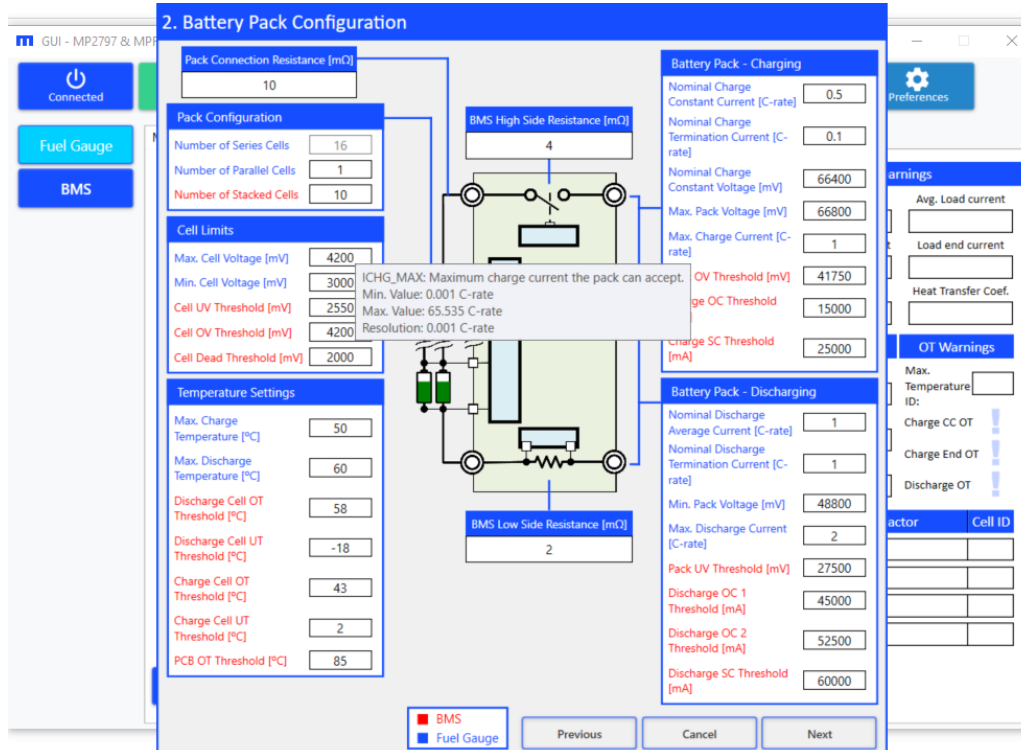

Figure 35: Configuration Wizard 3 – Battery Pack Configuration (Register Details)

11. It is recommended to carefully review the correct settings when configuring the battery match. A mismatch between these settings and the actual test set-up can reduce the state-of-charge (SoC). Double check the following parameters:
  - a. Nominal charge constant voltage: Set this value to the nominal voltage applied to the battery pack by the external charger during constant voltage (CV) charge.
  - b. Nominal charge constant current: Set this value to the nominal current applied to the battery pack by the external charger during constant current (CC) charge.
  - c. Nominal charge termination current: Set this value to the nominal current used to detect the end-of-charge stage during CV charge.
  - d. Pack empty voltage: Set this value to the voltage at which the battery pack would be considered completely discharged, and when the application would stop operation.
  - e. Nominal discharge average current: Set this value to the average current drawn by the load during normal operation.
  - f. Nominal discharge termination current: Set this value to the expected current value when reaching the end of discharge mode.
12. Once every register has been properly set, click “Next”.
13. The Temperature Sensor Selection window should automatically open. Set the number of temperature sensors used by the fuel gauge. In addition, set a selector for each cell, which selects which temperature sensor is associated with which cell (see Figure 36).

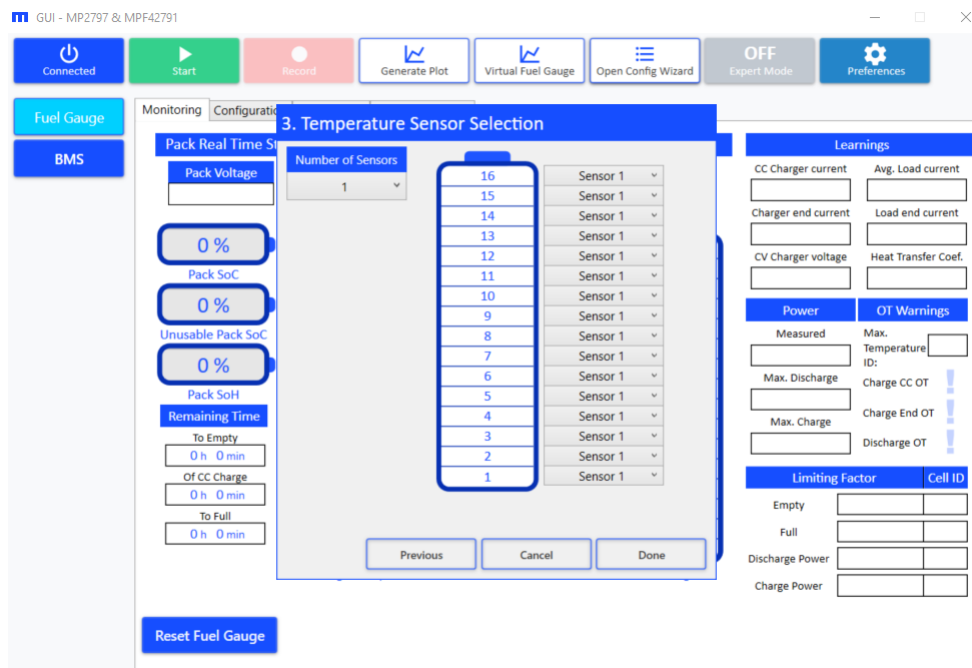

Figure 36: Configuration Wizard 4 – Temperature Sensor Selection

14. Click “Done” after making the configurations.

### 3.6 Expert Mode Configurations

#### Fuel Gauge Configurations

1. Select “Fuel Gauge” (denoted as “9” in Figure 28 on page 24).
2. Select the Configuration tab (see Figure 37 on page 30). There are three sub-tabs under the Configuration tab: General, FG Tuning, and LEDs Settings.

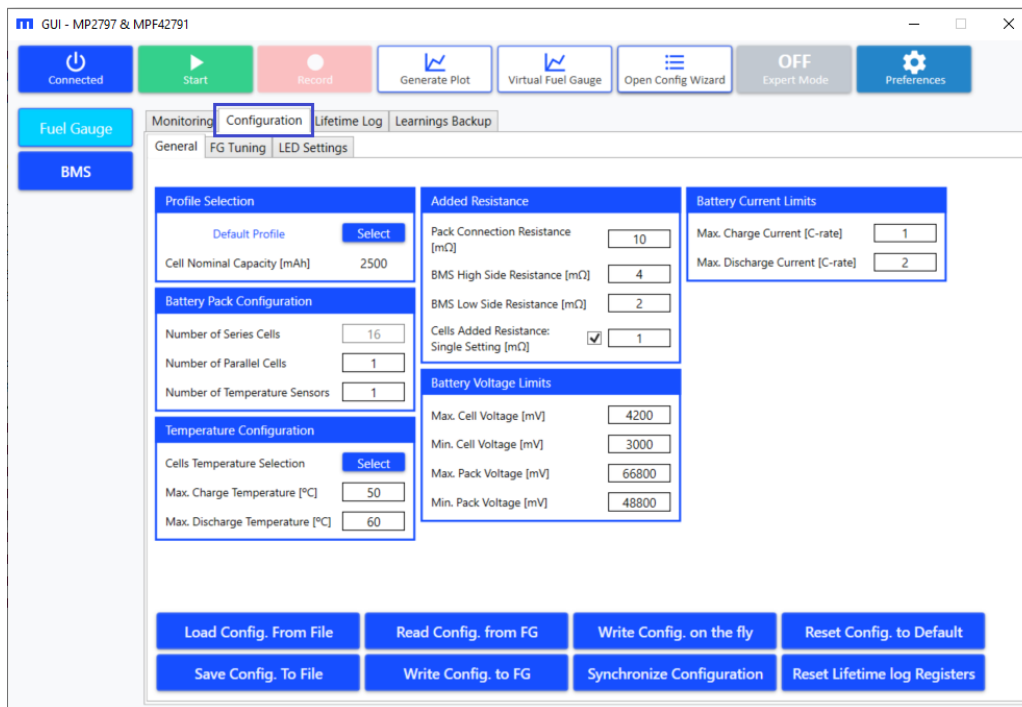

Figure 37: Fuel Gauge Configuration

3. To see the full set of registers to fine-tune the fuel gauge, select “Expert Mode” (denoted as “7” in Figure 28 on page 24). The full set of configuration registers should be displayed, as well as two extra sub-tabs: Learnings and Customer Block (see Figure 38). Figure 38 shows three “Select” buttons, discussed in greater detail below.

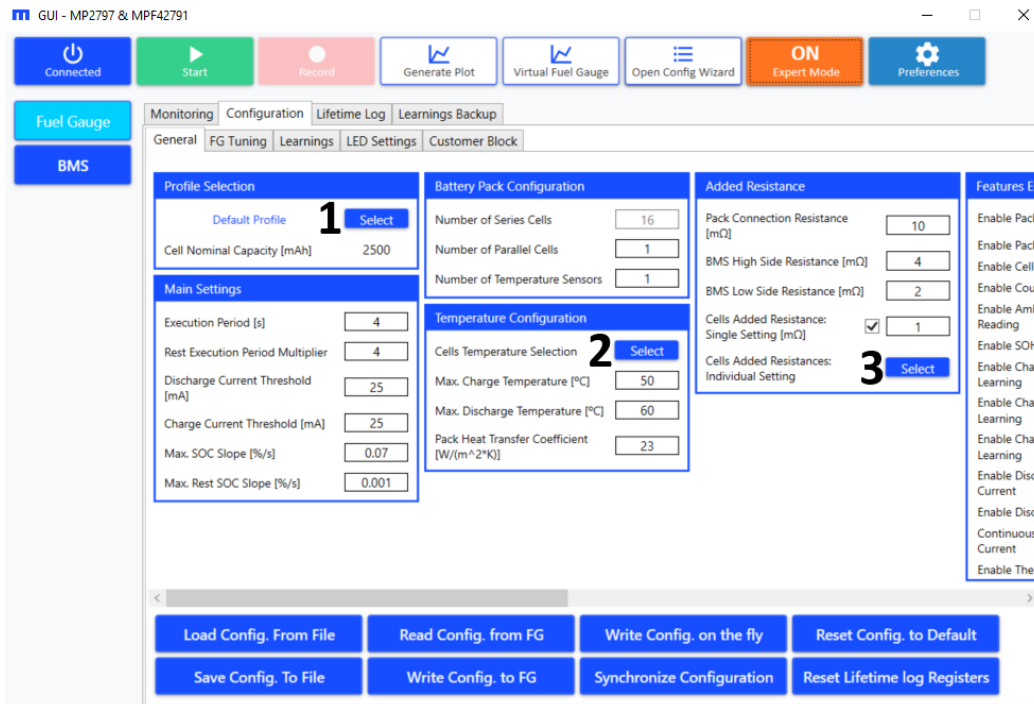

Figure 38: Fuel Gauge Configuration – Expert Mode

- a. The first “Select” button opens the wizard to select the cell profile (see Figure 39 on page 31).

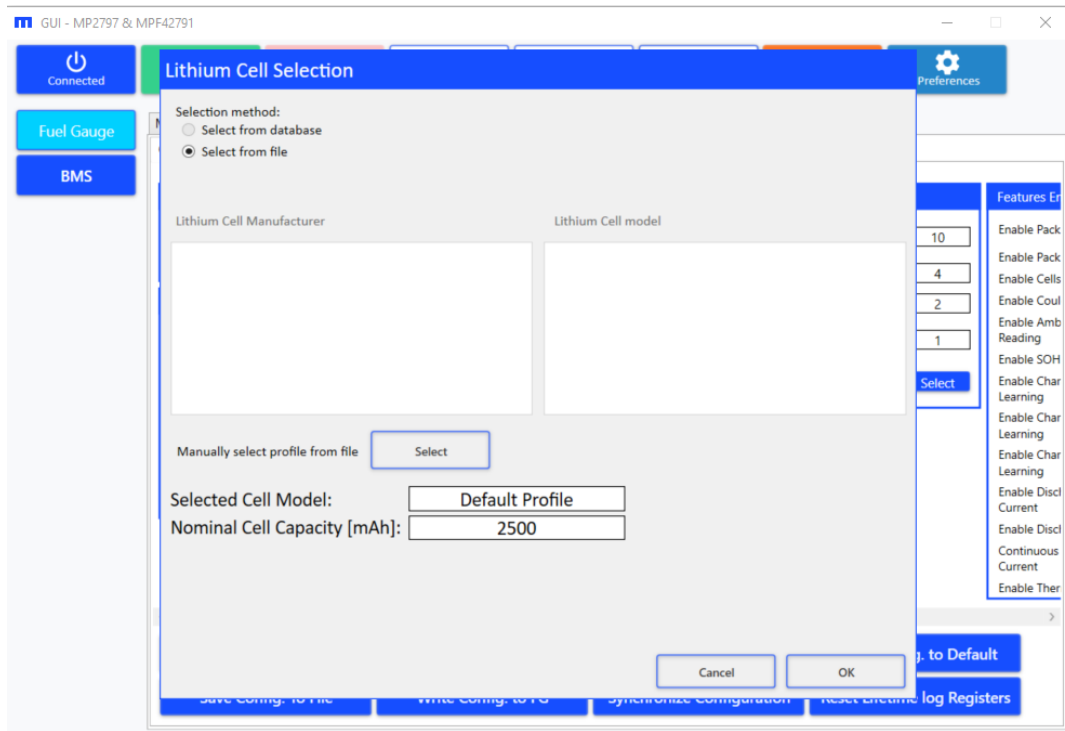

Figure 39: Lithium Cell Selection Window

- b. The second “Select” button opens the wizard to assign a temperature sensor to each cell (see Figure 40). Note that the number of temperature sensors should be set first.

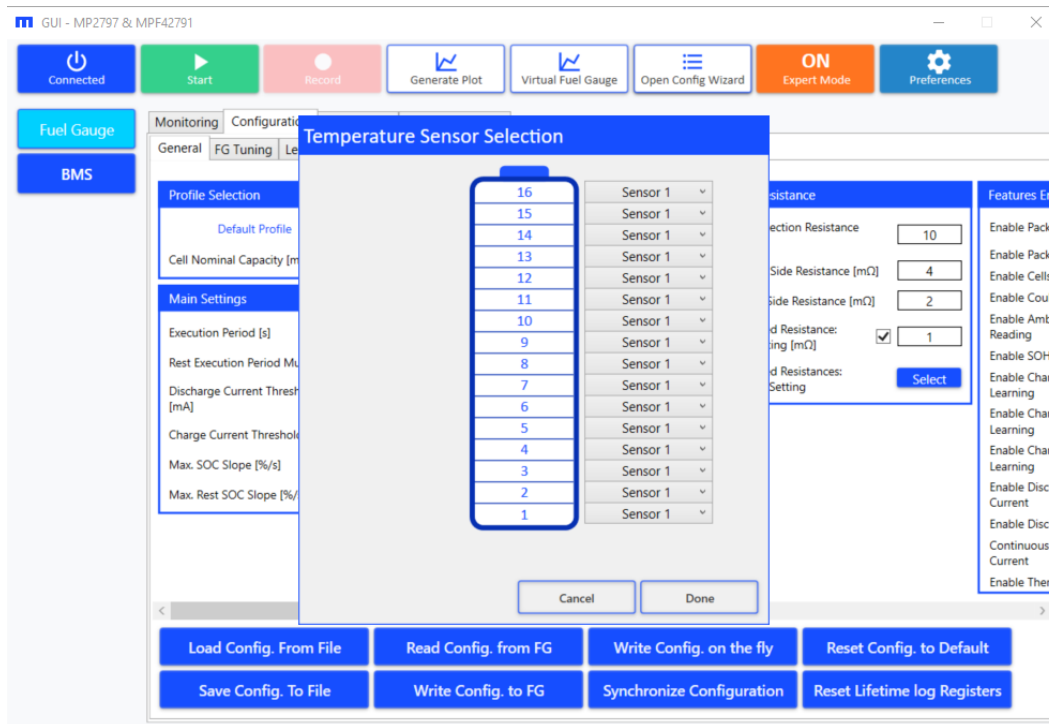

Figure 40: Temperature Sensor Selection Window

- c. The third “Select” button opens the wizard to introduce the added resistance from each cell’s connections (see Figure 41 on page 32). Alternatively, the “Cells Added Resistance: Single

Setting” can set a single value for all cells. A checkbox in the window allows users to enable or disable this option (see Figure 41).

If the “Cell Added Resistance” changes (either due to the GUI reading/importing a configuration or the user introducing a change), and each cell has a unique value, the single setting is disabled and displayed as “-”.

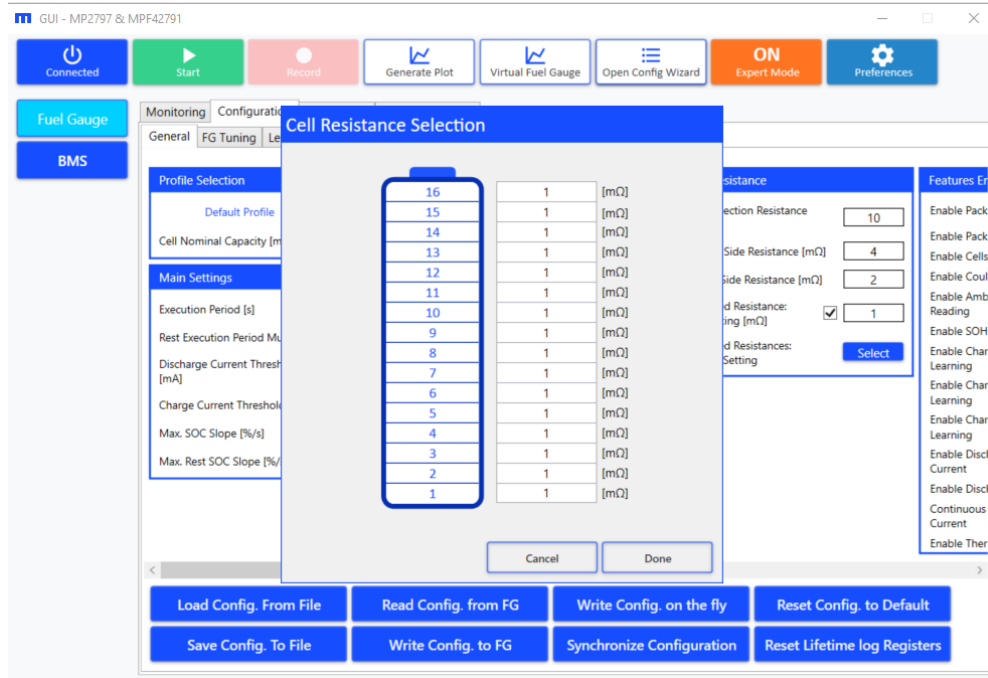

Figure 41: Cell Resistance Selection Window

- d. Place the cursor on top of a register name to display that register’s information (see Figure 42). For more detailed information on the registers, refer to the relevant MPF4279x datasheet.

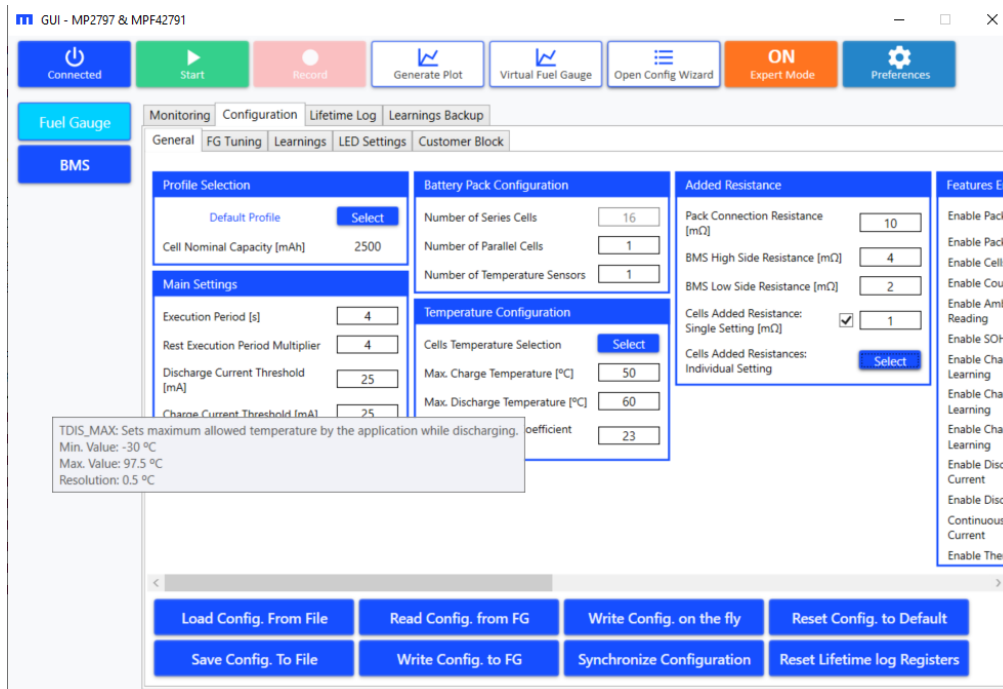

Figure 42: Fuel Gauge Configuration (Register Details)



### BMS Configurations

1. Click “BMS” (denoted as “10” in Figure 28 on page 24).
2. Select the Configuration tab (see Figure 43).

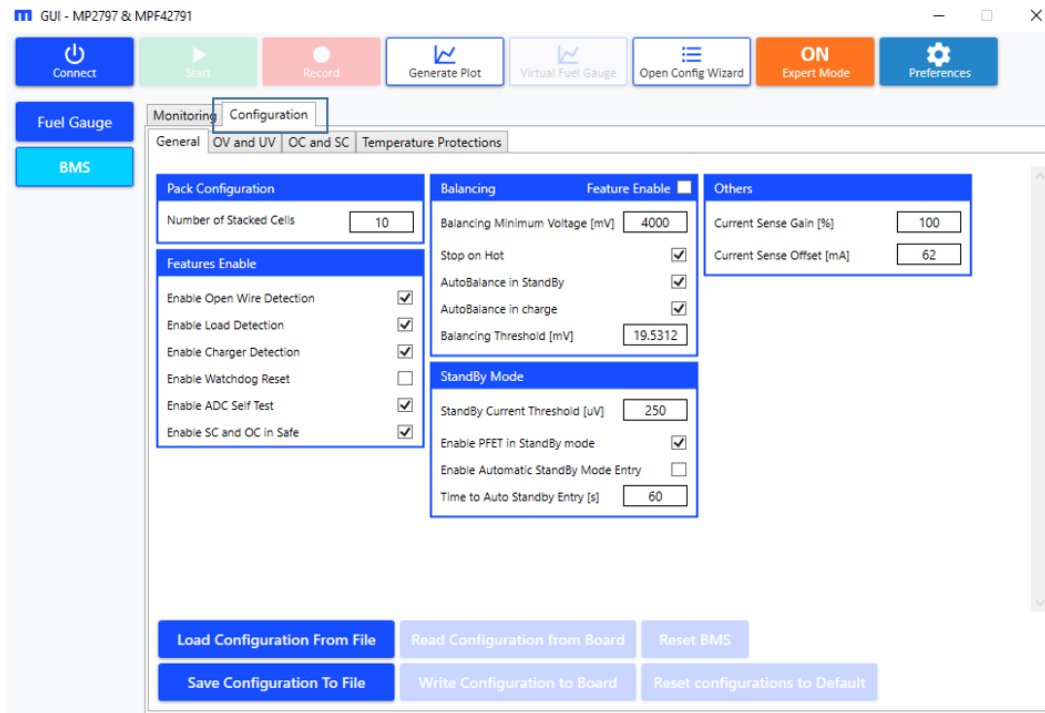

Figure 43: BMS Configurations

3. Place the cursor on top of the register name to display that register’s information of that register (see Figure 44).

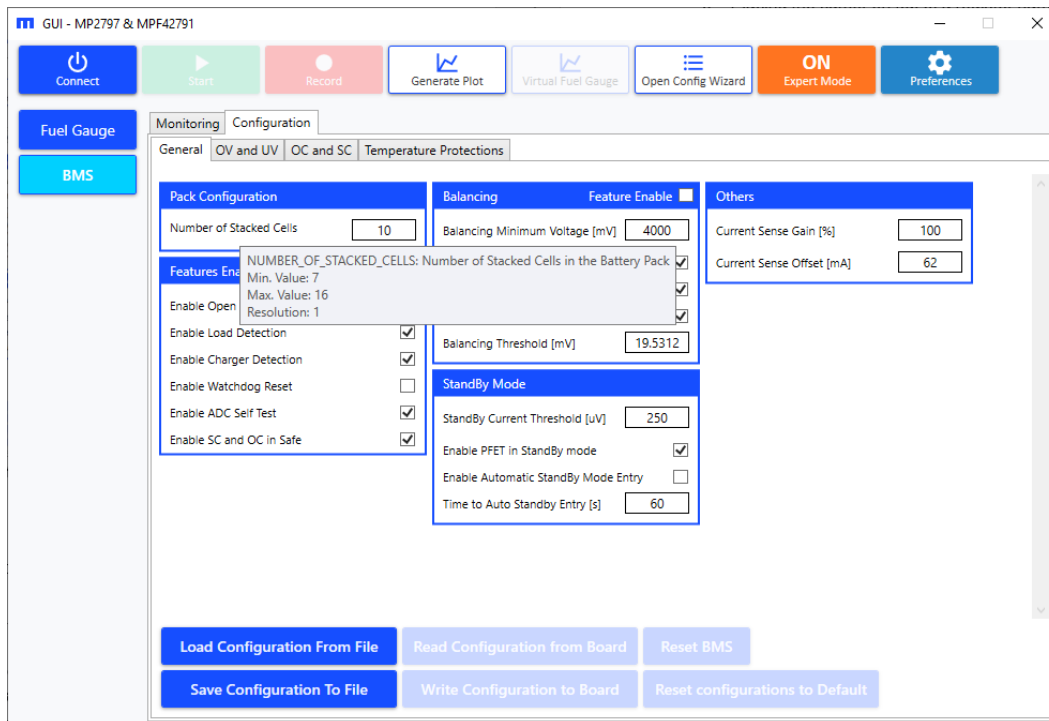

Figure 44: BMS Configurations (Register Details)

### 3.7 Read and Write Configurations

The functionalities listed below are only enabled if the devices have been successfully connected. See Section 3.3 on page 21 for more details.

#### Reads and Writes for Fuel Gauge Configurations

1. Click “Fuel Gauge” (denoted as “9” in Figure 28 on page 24).
2. Select the Configuration tab (see Figure 37 on page 30).
3. Click “Read Config. from FG” to read the configurations for the MPF4279x and overwrite the fuel gauge configurations of the GUI (denoted as “1” in Figure 45).
4. Click “Write Config. to FG” to write configurations stored in the GUI to both the non-volatile memory (NVM) and the volatile memory of the MPF4279x, and then trigger an FG reset (denoted as “2” in Figure 45).
5. Click “Write Config. on the fly” to write the configurations stored in the GUI to the volatile memory of the MPF4279x (denoted as “3” in Figure 45).
6. Click “Synchronize Configuration” to write the configuration registers in the MP4279x’s volatile memory to the NVM so that the changes are retained, even after a hard reset (denoted as “4” in Figure 45).

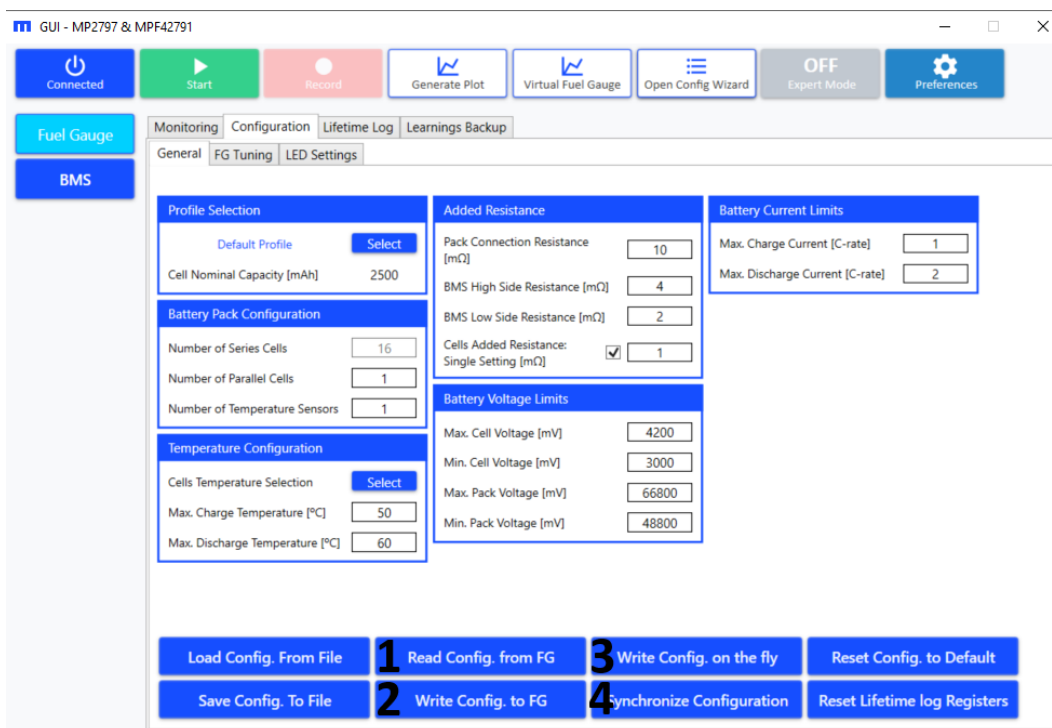

Figure 45: Fuel Gauge Configuration (Read and Write Buttons)

#### Reads and Writes for BMS Configurations

1. Click “BMS” (denoted as “10” in Figure 28 on page 24).
2. Select the Configuration tab (see Figure 43 on page 33).
3. Click “Read Configuration from Board” to read the configurations of the BMS and overwrite the BMS configurations in the GUI (denoted as “1” in Figure 46 on page 35).
4. Click “Write Configuration to Board” to write the configurations stored in the GUI to the memory of the BMS (denoted as “2” in Figure 46 on page 35).

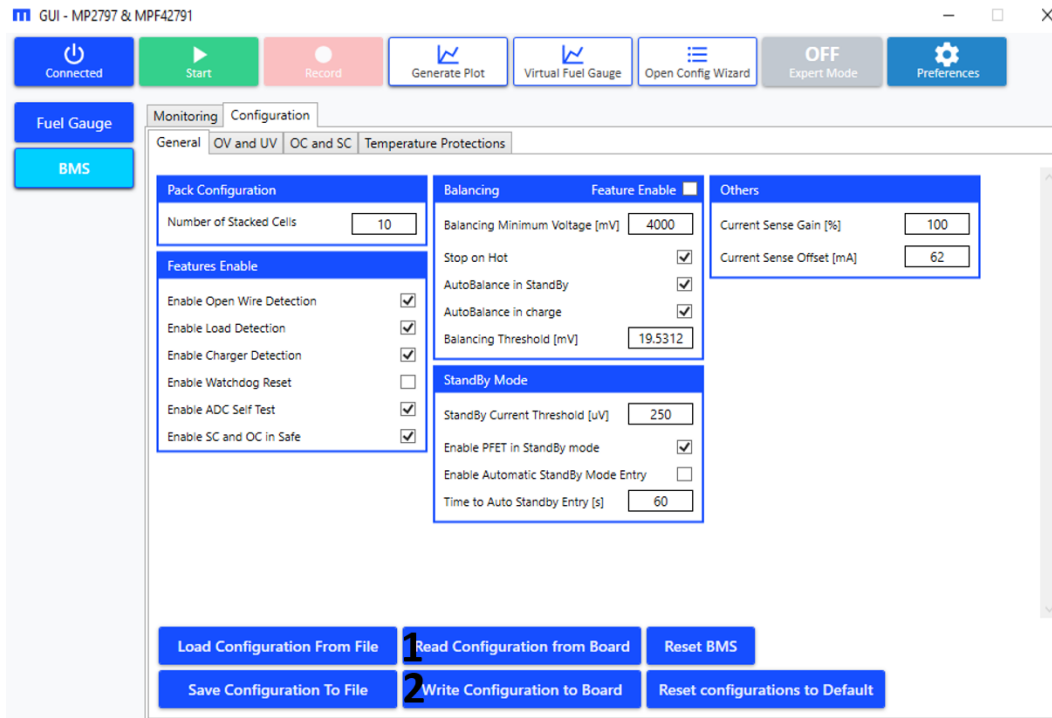

Figure 46: BMS Configuration (Read and Write Buttons)

### 3.8 Importing and Exporting Configurations

#### Importing and Exporting Fuel Gauge Configurations

1. Click “Fuel Gauge” (denoted as “9” in Figure 28 on page 24).
2. Select the Configuration tab (see Figure 42 on page 32).
3. Click “Load Configuration from file” to open the file explorer (denoted as “1” in Figure 47 on page 36). Select a configuration file. If the file contains configurations that are in the correct format, the configuration parameters in the GUI are overwritten (see Figure 47 on page 36).
4. Click “Save Configuration to file” to open the file explorer (denoted as “2” in Figure 47 on page 36). Select the directory and the filename of the exported configuration file, which contains all configurations from the Fuel Gauge (see Figure 47 on page 36).

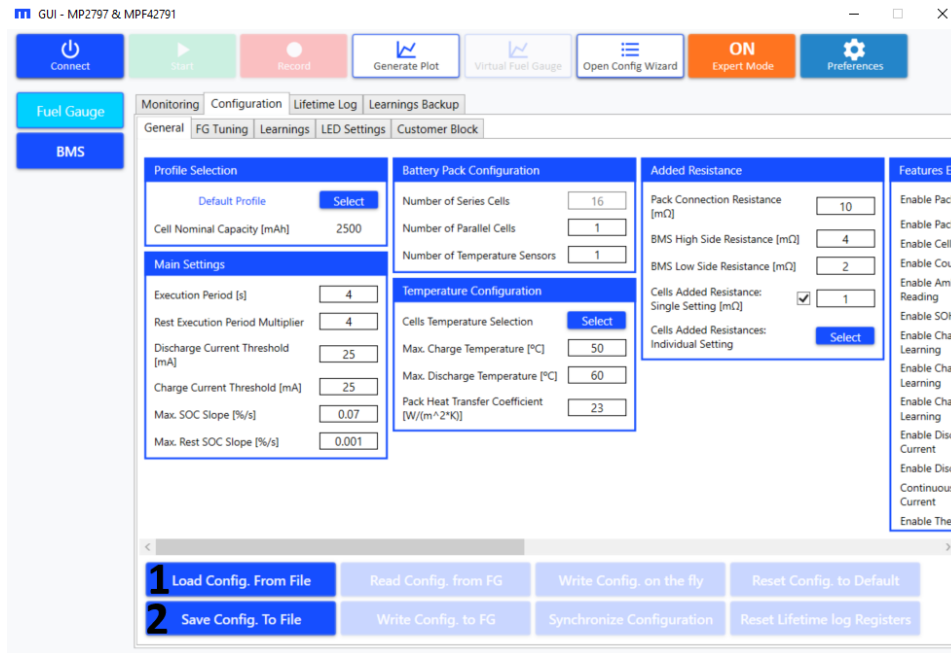

Figure 47: Fuel Gauge Configuration, Load and Save Buttons

### Importing and Exporting BMS Configurations

1. Click “BMS” (denoted as “10” in Figure 28 on page 24).
2. Select the Configuration tab (see Figure 43 on page 33).
3. Click “Load Configuration from file” to open the file explorer where a BMS configuration file can be selected (denoted as “1” on Figure 48). If the file containing the BMS configurations is in the correct format, the BMS configuration parameters of the GUI are overwritten (see Figure 48).
4. Click “Save Configuration to file” to open the file explorer (denoted as “2” on Figure 48). Select the directory and the filename of the exported configuration file, which contains the BMS configuration (see Figure 48).

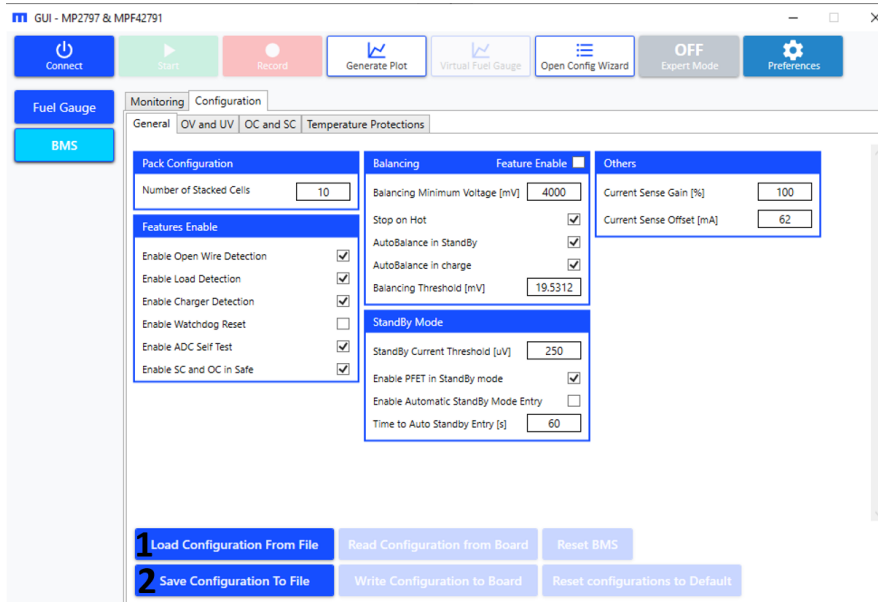

Figure 48: BMS (Load and Save Buttons)

### 3.9 Monitoring and Recording

The functionalities listed below are only enabled if the devices have been successfully connected. See Section 3.3 on page 21 for more details.

#### Monitoring

1. Click “Start” (denoted as “2” on Figure 28 on page 24). The GUI should start reading all monitoring registers continuously. After clicking “Start”, this button will be displayed as “Stop” (see Figure 49). For more details on the displayed registers, refer to the MPF4279x datasheet.
2. Figure 49 show the fuel gauge’s Monitoring window.

Note that displays for 11 cells to 16 cells are be grayed out for EVKT-BMU10S (MPF42795) and EVKT-BMU10SNL (MPF42797), as the fuel gauge ICs for these boards only supports up to 10 cells in series.

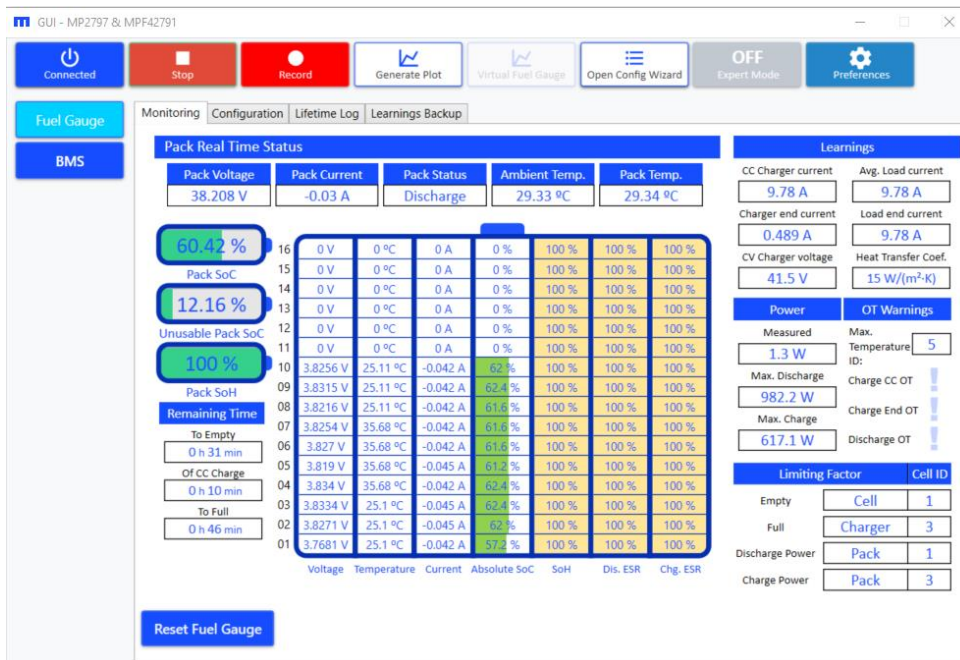

Figure 49: FG Monitoring

3. Figure 50 and Figure 51 on page 38 show the BMS Monitoring windows.

Note that the voltage for cell 15 and cell 16 and all cell currents that are displayed as a dash (“-”) in evaluation kits that are paired with the MP2791.

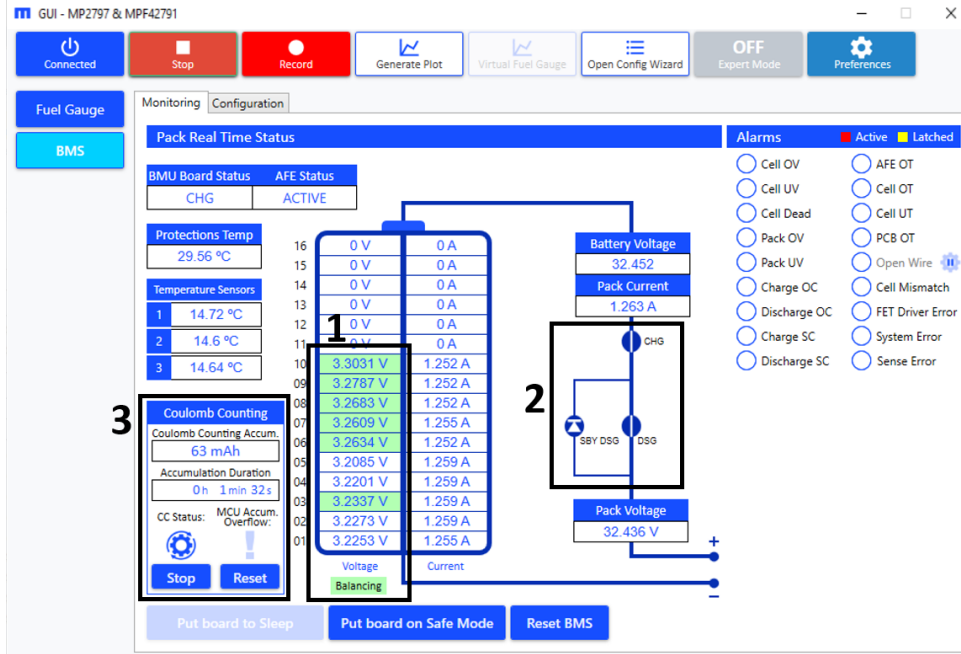

Figure 50: BMS Monitoring 1

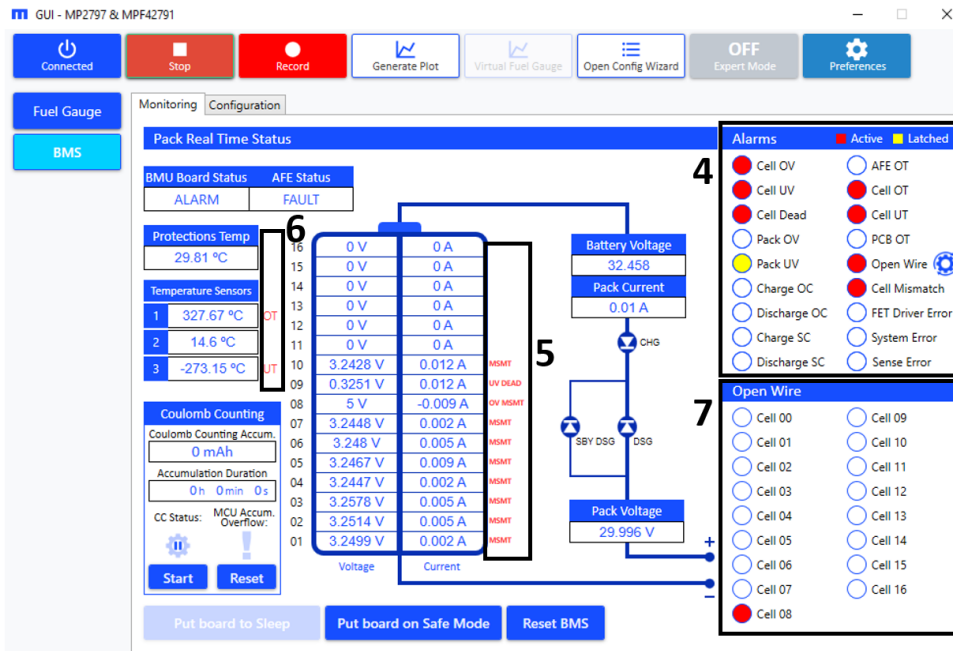

Figure 51: BMS Monitoring 2

- If a cell is balancing, the background of its displayed voltage is highlighted and a legend appears below the voltage title (see Figure 50).
- The status of each protection FET is displayed. If the FET is displayed as a diode, this means that the FET is open; otherwise, the FET is closed (see Figure 50).
- If requested, the MCU can accumulate the Coulomb counting readings from the MP279x. The user can start and stop the accumulation of these readings and can even reset them to 0. Coulomb counting is paused in alarm and safe states, which means that the MCU also stops accumulating readings in this state.

7. In the Alarms display, an alarm is displayed in red if the conditions to trigger the alarm are met. An alarm is displayed in yellow when the alarm’s conditions are no longer met but the status is latched. An alarm is displayed in white if an alarm is neither active nor latched (see Figure 51 on page 38).

To clear the latched status of an alarm, place the board in safe or standby mode (see Section 3.12 on page 41 for more details).

If a fault is disabled but the fault conditions are met, the fault is displayed but the BMS does not enter alarm mode (see Figure 50 and Figure 51 on page 38).

- 8. Each cell has a display that shows the real-time status for over-voltage (OV), under-voltage (UV), dead (DEAD), and mismatch (MSMT) conditions.
- 9. Each temperature sensor has a display showing the real-time status for over-temperature (OT) and under-temperature (UT) conditions.
- 10. If an open-wire alarm is active, a display should appear and indicate which wire is open. Cell x stands for a cell’s positive sensing wire. Cell 00 stands for a cell’s negative wire.
- 11. To stop monitoring, click “Start”. It should update to “Stop” (see Figure 50 on page 38).

**Recording**

- 1. While the GUI reads the monitoring registers, the “Record” button is enabled (see Figure 52).
- 2. Click “Record”. The GUI should generate a folder with three files in the export directory (see Section 3.4 on page 26 for more details.) These three files are two “.xml” exports for the fuel gauge and BMS configurations, respectively, and one “.csv” file to log the monitoring registers while the recording function is enabled. After clicking “Record”, it should change to display “Stop Recording”.
- 3. Click “Stop Recording” to stop logging into the .csv file (see Figure 52).
- 4. If a user clicks “Write Config. on the fly” while recording, an additional “.xml” file is generated. This file contains the new configuration, which is written to the board. The name of this file contains the time at which the file was generated within the recording.



Figure 52: Recording

If the board is disconnected during either a reading or recording process, both reading and recording stop. In addition, if reading is stopped, this will also stop recording.

### 3.10 Plotting

1. Click “Generate Plot” (denoted as “4” on Figure 28 on page 24).
2. The Generate Plot window should open. In this window, the user can select a “.csv” file to plot, as well as the directory to which the plots are stored. The default destination folder is configured via the GUI’s Preferences section (see Section 3.4 on page 26) (see Figure 53).



Figure 53: Plotting Wizard

3. Once the file and destination folders are selected, click “Generate”. The GUI should generate the plots for that “.csv” file and store the results in a folder that is inside the destination folder directory, with the same name as the “.csv” file. This can take up to several minutes, depending on the size of the “.csv” file.
4. The GUI should open the folder with the plots in the file explorer once plotting is complete.
5. The plots are saved in an “.html” format, and can be opened with any standard browser software.

### 3.11 Learnings

This function is only enabled if expert mode is activated. In addition, this tab is only available in the next generation of evaluation boards (e.g. the EVKT-BMU1xx-G1), when the board is paired with the MPF42791. However, some of these configurations are available for the older generation devices in the “FG Tuning” tab.

The new generation offers a wide variety of learning configurations that can enhance performance. Hover the cursor over a parameter to read about that parameter’s information (see Figure 42 on page 32).

After tailoring the FG learnings, load the desired configuration into the FG (see Figure 54 on page 41). For more details, read section 3.7 on page 34.



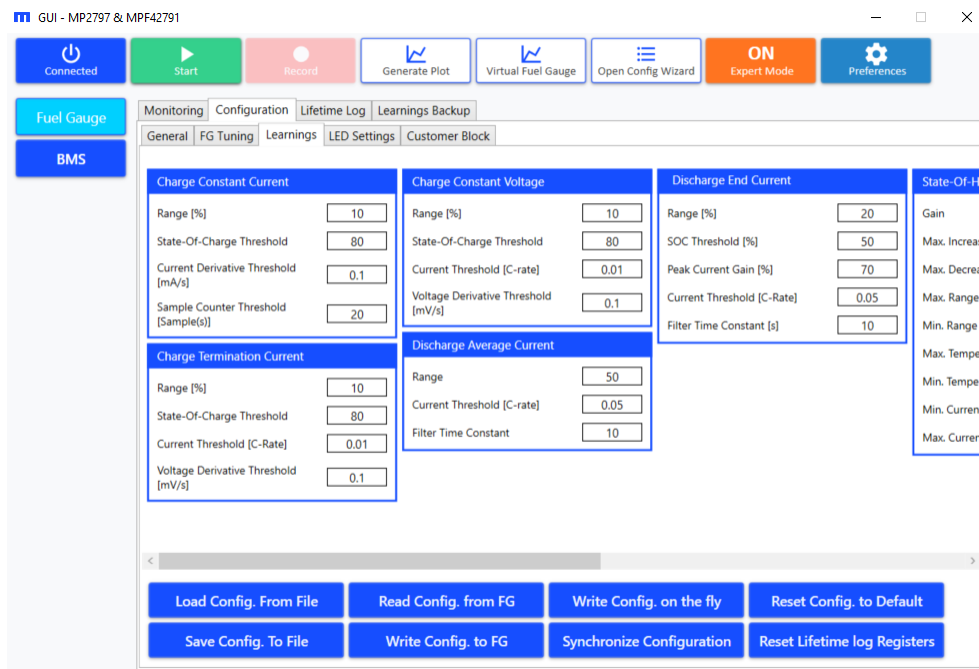

**Figure 54: Learning Tab**

### 3.12 LED Settings

The write functionalities are only enabled if the connect function has been completed (see Section 3.3 on page 21 for more details). Note that the LEDs are only available for the EVKT-BMU16S, next generation devices, and the EVKT-BMU10s (e.g. the MPF42795).

1. Click “Fuel Gauge” (denoted as “9” on Figure 28 on page 24).
2. Select the Configuration tab and click on the “LED Settings” sub-tab (see Figure 37 on page 30).
3. Set the LED parameters and write the values to the MPF4279x (see Figure 55 on page 42).
  - a. Click “Write LED Settings” (denoted as “1” in Figure 55 on page 42). Write the LED settings to the volatile memory of the MPF4279x. Note that these changes only last until they are overwritten, or a hardware reset occurs. This function can be used while reading is active.
  - b. Click “Write Config. on the fly” (denoted as “2” in Figure 55 on page 42). This writes both the fuel gauge settings and the LED settings into the volatile memory of the MPF4279x. Note that these changes only last until they are overwritten, or a hardware reset occurs. This function can be used while reading is active.

Note that the changes written to the volatile memory can be stored to the NVM to be used as default values after the device experiences a hard reset (via a power reset or toggling the RST pin). To save the changes, click “Synchronize Configuration” (denoted as “4” in Figure 55 on page 42).

- c. Click “Write Config. to Fuel Gauge” (denoted as “3” in Figure 55 on page 42). The settings under this tab are stored in both the volatile and the non-volatile memory of the MPF4279x, and are used as default values after the device experiences a hardware reset (see Section 3.7 on page 34 for more details).

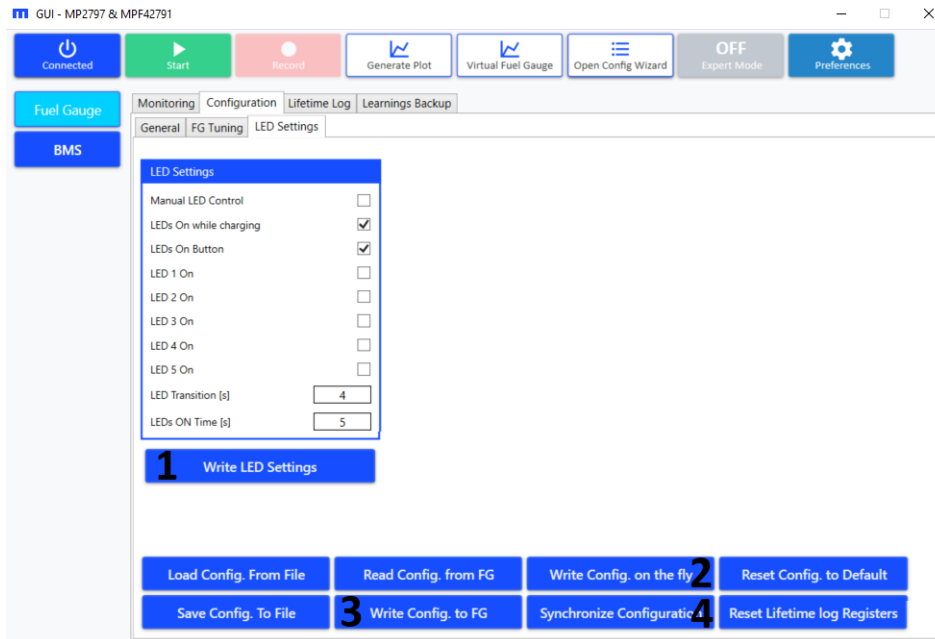

**Figure 55: LED Settings**

### 3.13 Customer Password

This function is only enabled if expert mode is activated, and when the GUI is not reading. In addition, this tab is only available in the next generation of evaluation boards (e.g. the EVKT-BMU1xx-G1), when the board is paired with the MPF42791.

The next generation FG allows the designer to block the edition of the cell model, so that the end user to cannot change the cell model configuration.

1. Click the “Customer Password” tab on the Configuration page.
2. The GUI should show the default Customer Block Password (denoted as “2” in Figure 56 on page 43).
3. To change the password, write the new pass into Customer Block New Password (3) (denoted as “3” in Figure 56 on page 43).
4. Ensure that the customer block is disabled, then click “Set” (denoted as “4” in Figure 56 on page 43).
5. If the “Set” button is disabled, click “Read Customer Block Status” (denoted as “5” in Figure 56 on page 43). A message reading “Successfully Set New Password” should appear if the operation was successful (see Figure 56 on page 43).
6. To enable the customer block, click “Enable” (denoted as “1” in Figure 56 on page 43). Then enter the correct password. A message reading “Successfully completed operation” should appear; otherwise, this feature is blocked after 3 additional incorrect attempts.
7. To disable the customer block, click “Disable” (denoted as “1” (“Enable”) in Figure 56 on page 43). Then enter the correct password. A message reading “Successfully completed operation” should appear; otherwise, this feature is blocked after 3 additional incorrect attempts.

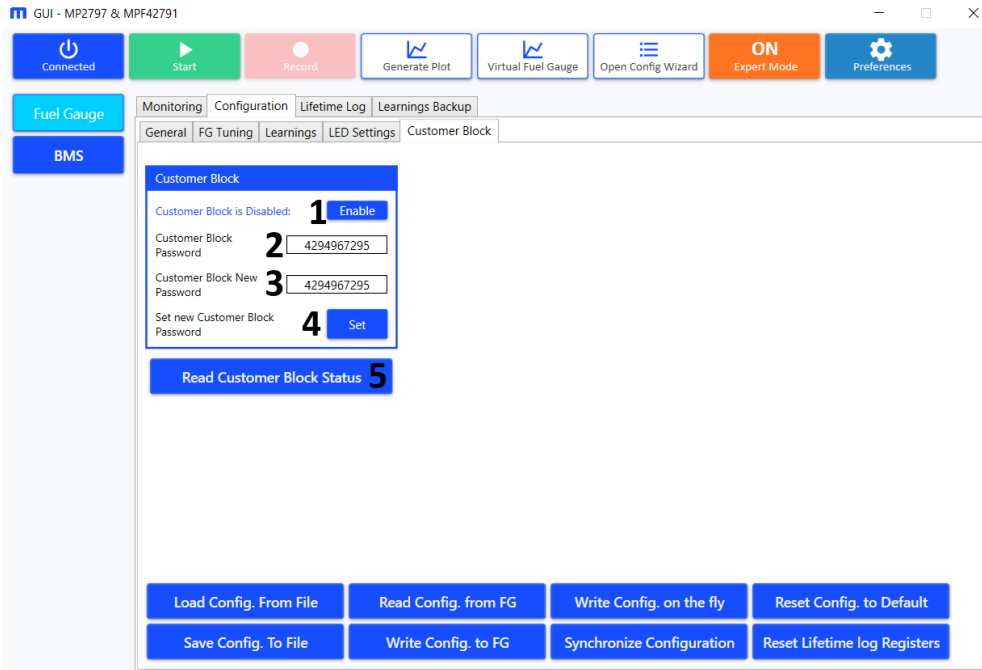

Figure 56: Customer Password Tab

### 3.14 Virtual Fuel Gauge

This function is only enabled if the connect function has been completed (see Section 3.3 on page 21 for more details). It cannot be used while the GUI monitors the registers (see Figure 49 on page 37).

The virtual fuel gauge function allows users to re-run the real tests that were saved, without needing a real battery (see Section 3.9 on page 37). This function runs the configuration that was loaded into the fuel gauge. Upload a new configuration if needed (see Section 3.8 on page 35 for more details).

1. Click “Virtual Fuel Gauge” (denoted as “5” on Figure 28 on page 24).
2. The Virtual Fuel Gauge window should open (see Figure 57).



Figure 57: Virtual Fuel Gauge Main Menu

3. Select the recorded “.csv” file to re-run using the explore button (see Figure 58).

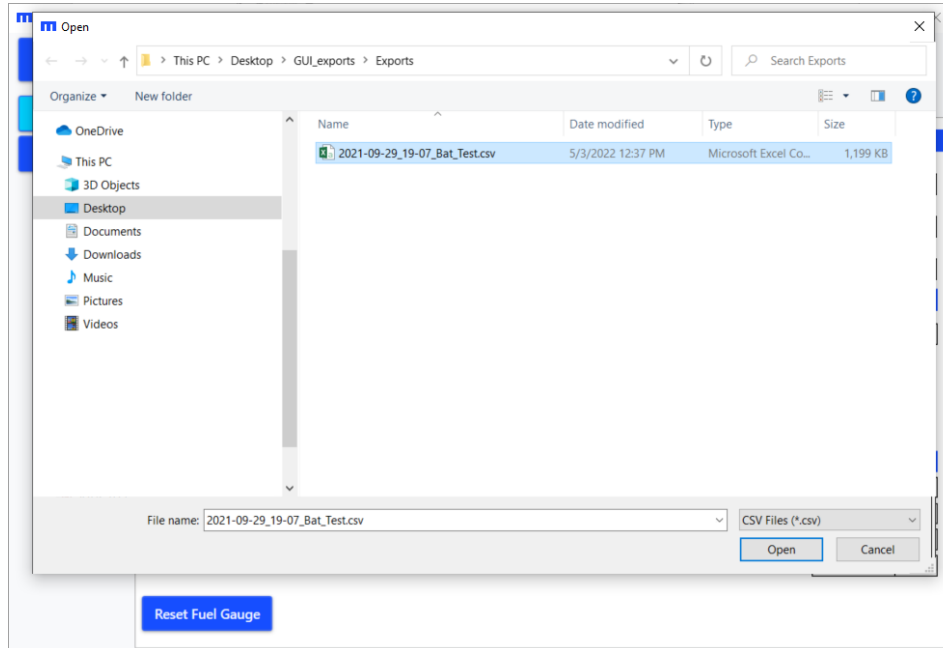

Figure 58: Virtual Fuel Gauge Select Input File

4. Select the number of iterations to run on the same data file, and users can select which fuel gauge estimates can be reset during the first iteration (and between iterations). For example, if the start of the file does not match the end, reset everything before the first iteration, and only reset the state-of-charge (SoC) between iterations (see Figure 59).



Figure 59: Virtual Fuel Gauge – Valid File Selected

To speed up this test, select another execution time for the virtual fuel gauge. The GUI should detect the execution period during the recording, and should be able to use this value or a multiple of it. Higher periods are executed more quickly, but they can be less accurate.

- Select “Exit Virtual FG Mode when done” to disable virtual fuel gauge mode on the evaluation board once all the iterations are done. Then the fuel gauge runs with the readings from its own board, and not the readings from the GUI. Otherwise, this process can be manually exited by clicking “Exit Virtual FG Mode” (see Figure 59 on page 44).

Figure 60 shows how to reset the fuel gauge.

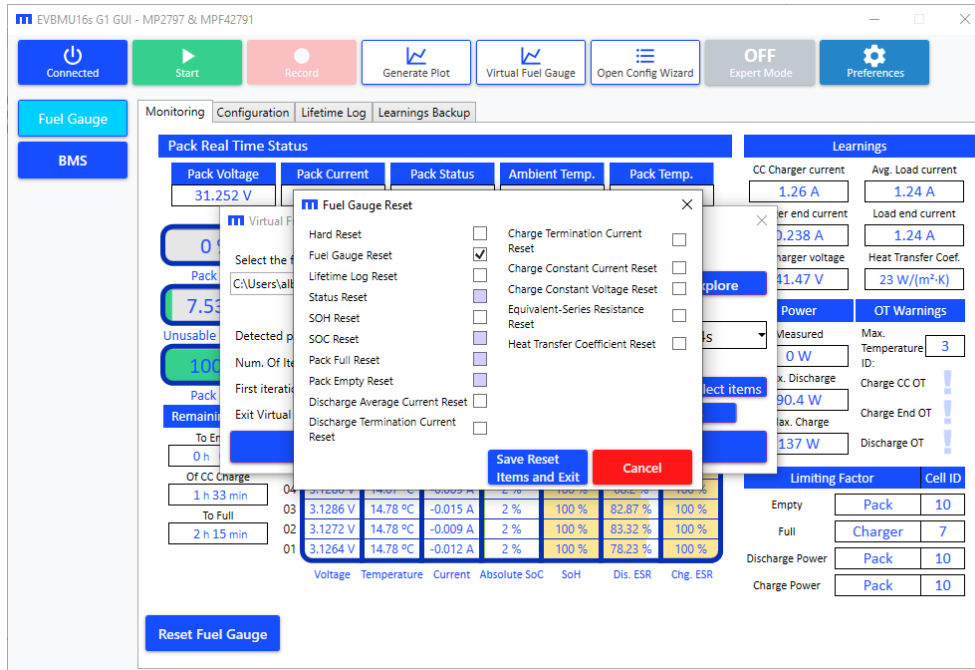

Figure 60: Virtual Fuel Gauge (Selecting Reset Items)

- Once a valid file is selected, click “Generate” to start a test. A window should appear to allow the user to select where the test results are stored (see Figure 61).

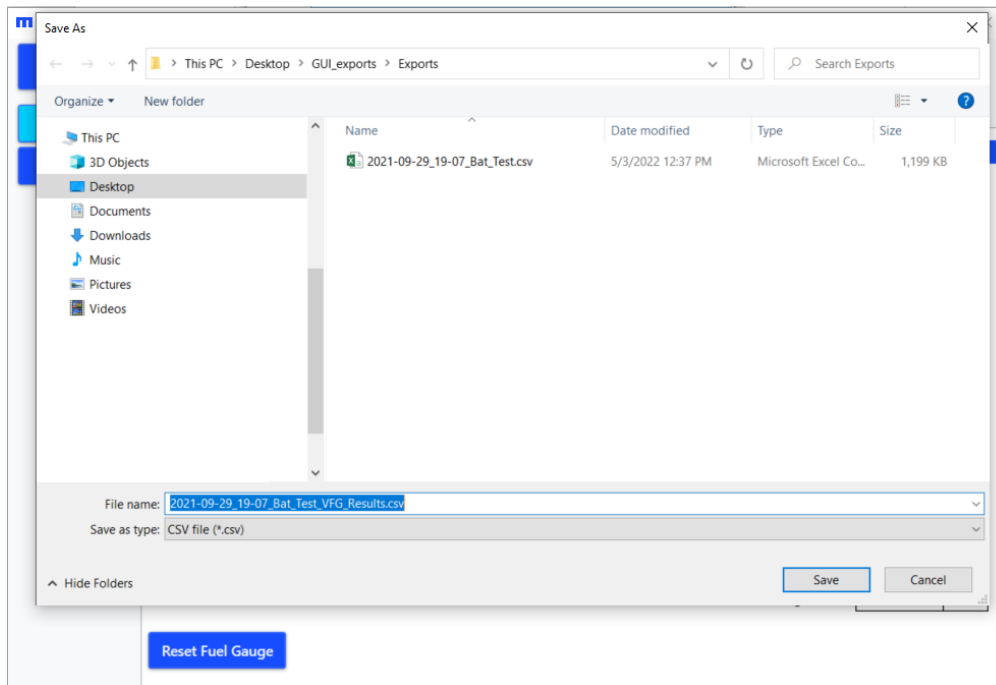

Figure 61: Virtual Fuel Gauge (Store Results)

- The virtual fuel gauge should run the tests. There are two progress bars to indicate the status of this process, as well as the ongoing iteration. The window also displays the estimated remaining time (see Figure 62).

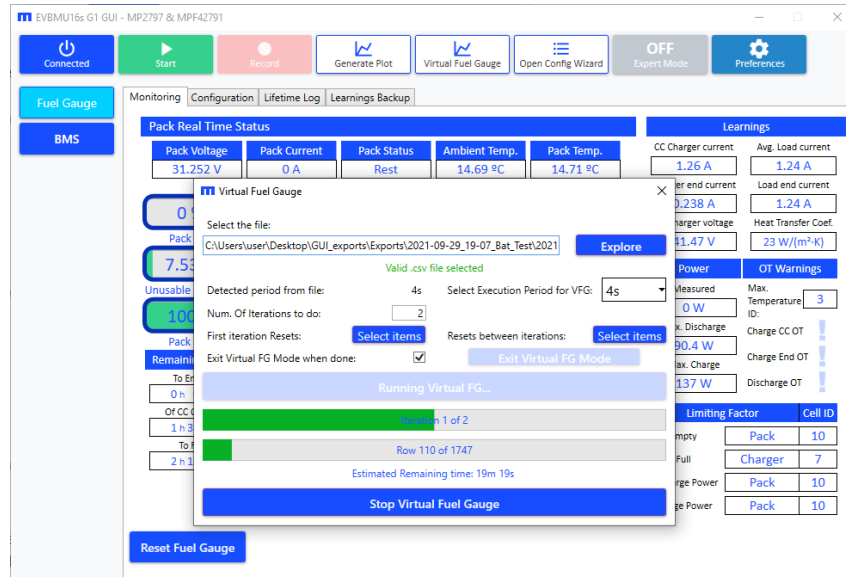

Figure 62: Virtual Fuel Gauge (Running)

### 3.15 Others

This function is only enabled if the connect function has been completed (see Section 3.3 on page 21 for more details).

- Reset the fuel gauge algorithm:** Click “Reset Fuel Gauge” under the “Monitoring” tab for the fuel gauge device. A window should open, which allows users to select different fuel gauge estimates to re-initialize. The selected reset commands only be sent if this function is enabled and the board is connected.

Note that resetting one item may also reset additional items. If this going to occur, the additional item(s) being reset will have a checkbox that is marked blue (see Figure 63).

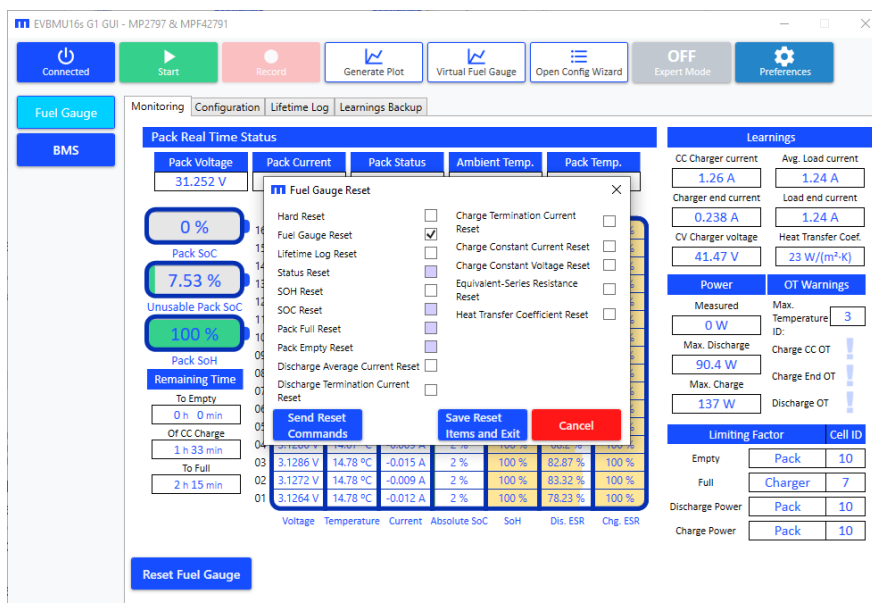

Figure 63: Fuel Gauge Reset Dialog

2. Reset fuel gauge configurations to the default values: Click “Reset Configuration to Default” under the Configuration tab of the fuel gauge device to re-initialize the MPF4279x configuration registers to their default value.
3. Lifetime log registers: The MPF4279x family provides a lifetime logging capability to keep track of certain parameter across a battery’s (and its cells’) lifetime.
  - a. To access the lifetime log view in the GUI, click the Lifetime Log tab in the Fuel Gauge device window (see Figure 64).
  - b. Click “Read LTL Registers” (denoted as “1” in Figure 64). Then users can read the life time log registers and have them displayed in the lifetime log view.
  - c. Click “Save LTL registers” (denoted as “2” in Figure 64). This exports a “.txt” file for the fuel gauge’s lifetime log registers.
  - d. Click “Reset Lifetime log Registers” (denoted as “3” in Figure 64). This re-initializes the MPF4279x’s lifetime log registers.

Refer to the MPF4279x datasheet for more information regarding the lifetime log.



Figure 64: Lifetime Log View

4. Learning values backup: The older generation MPF4279x devices do not retain the results from their long-term learnings after being disconnected from the power supply. However, there are external backup capabilities for these registers. The newer generation devices retain their set values after a shutdown, but the reading values can be directly written (e.g. keeping the learnings values in the new IC after exchanging the BMS for a battery).
  - a. To access the learnings backup view in the GUI, click the Learnings Backup tab in the Fuel Gauge device window (see Figure 65 on page 48).
  - b. Click “Read Learning Values” (denoted as “3” in Figure 65 on page 48). Then read the long-term learning values and display them in the Learnings Backup view.
  - c. Click “Save Learning Values” (denoted as “1” in Figure 65 on page 48). This exports a “.txt” file the long-term learning values of the fuel gauge.

- d. Click “Load Learning Values” (denoted as “3” in Figure 65). This imports the fuel gauge’s long-term learning values as a “.txt” file.
- e. Click “Write Selected” (denoted as “4” in Figure 65). This performs a backup for the learnings selected, using the designated check boxes. Selected learnings are reinitialized in the MPF4279x to their target values; unselected learnings are not reinitialized.
- f. Click “Write All” (denoted as “5” in Figure 65). This performs a backup for all the learnings. All learnings are reinitialized in the MPF4279x to their target values.



**Figure 65: Learnings Backup View**

5. Reset the BMS: Click “Reset BMS” under the BMS device’s Configuration tab to perform a reset on the BMS’ main MCU. This also resets the MP279x. This function can clear certain alarms (e.g. an under-voltage alarm) after being configured to a different number of cells in series.
6. Reset BMS configurations to their default values: Click “Reset Configuration to Default” under the BMS device’s Configuration tab to reinitialize the BMS configuration registers to their default values, which are stored in the MCU’s flash memory.
7. Put the board to sleep: This function is only enabled if the GUI is not reading, since activity on the UART wakes up the board.
  - a. Click “Put Board to sleep” under the BMS device’s Monitoring tab to put the board to sleep and minimize power consumption. Any action that requires communication with the evaluation board will wake it up, including clicking “Put Board to sleep” again. In this scenario, the button’s text changes.
  - b. Put the board to sleep to clear the latch-off alarms (if they are not active).
8. Put the board in safe/active mode: The board can be forced into both safe and active mode.
  - a. Click “Put Board in Safe Mode” under the BMS device’s Monitoring tab to open the protections and put the BMS in safe mode. Click this button again to put the board in active mode and close the protections. In this scenario, the button’s text changes.
  - b. Put the board to sleep to clear the latched alarms (if they are not active).



## Section 4. EVBMU1xx-R-00A as a BMS using the MP2797/MP2791

The EVBMU1xx-R-00A is a reference design board including the MP279x, a BMS solution acting as an AFE and protector with a high-side, N-channel MOSFET driver; and the MPF4279x, a fuel gauge solution. This section will discuss how to implement the MP279x. For more details regarding the MPF4279x refer to the MP279x datasheet and application note. Contact and MPS FAE for the application note.

### 4.1 Features

The following sections detail how to implement the MP279x.

#### High-Resolution ADC Readings

Each 500ms (or each 1000ms while in safe/alarm mode), a high-resolution scan is requested for the following measurements:

- Synchronous voltage and current readings of all active cells (NUMBER\_OF\_STACKED\_CELLS). This feature allows for a more accurate cell ESR and added resistance estimate for fuel gauge solutions, (e.g. the MPF4279x), which provides more accurate state-of-charge (SoC) estimates.
- Synchronous voltage and current reading for the battery voltage at the BMS input. This feature allows for a more accurate estimate for the battery's connection resistance. This BMS estimate for fuel gauge solutions (e.g. the MPF4279x) provides more accurate SoC estimates.
- While in an active mode (the charge (CHG) or discharge (DSG) state), Coulomb counting runs continuously to feed the fuel gauge. The user can use a dedicated bit to enable Coulomb counting accumulation. If this feature is enabled, the MCU accumulates the Coulomb counting readings to track how much current has flown in and out of the battery.
- Pack voltage reading for the output of the BMS. This reading helps more accurately predict the empty and full SoC thresholds for the MPF4279x.
- Three external NTC temperature sensors to sense the temperature of the cells, and one internal temperature sensor to sense the temperature for BMS protections. The MP279x offers a radiometric reading for the NTCs to ensure that the temperature reading is independent of possible fluctuations from the NTCB supply voltage. To minimize current consumption, the NTCB supply voltage turns on only while reading the NTC voltage.

Fast ADC readings each handle protections at 254ms. The following are named as Slot A conversions, and are automatically handled by the MP279x:

- All active cells voltages
- Battery voltage at the BMS's input
- Cells temperatures using the external NTCs
- Protection temperatures using the on-board NTC
- MP279x die temperature.
- REGIN (5V), 3.3V, and VDD (1.8V) supply voltages for the MP279x
- ADC self-test (if enabled, a measurement of the ADC reference voltage)

The MP279x offers a fast reaction after over-current (OC) and short-circuit (SC) conditions due to the independent comparators connected to the MP279x's current-sense input.

#### Balancing

Note that balancing does not occur if the device is in alarm, standby, or DSG mode. For more details on using the UART command, see Section 5 starting on page 62.

1. Enable cell-balancing.
  - a. Using the GUI: BMS > Configuration > General > Balancing > Feature Enable
  - b. Using the UART command: REG0x7FC4{7} (ENABLE\_BALANCING)
2. Configure the minimum voltage at which a cell can be balanced.
  - a. Using the GUI: BMS > Configuration > General > Balancing > Balancing Minimum Voltage
  - b. Using the UART command: REG0x7FB9 (BALANCING\_MINIMUM\_VOLTAGE)
3. Configure the cell-balancing threshold.
  - a. Using the GUI: BMS > Configuration > General-> Balancing > Balancing Threshold
  - b. Using the UART command: REG0x7FBB{8:4} (BALANCING\_THRESHOLD)
4. Enable cell-balancing when the standby current levels detected, certain conditions are met, and the related bit is enabled.
  - a. Using the GUI: BMS > Configuration > General > Balancing > Auto-Balance in Standby
  - b. Using the UART command: REG0x7FBB{0} (AUTOBALANCE\_IN\_STANDBY)
5. Enable cell-balancing when the charge current levels are detected, certain conditions are met, and the related bit is enabled.
  - a. Using the GUI: BMS > Configuration > General > Balancing > Auto-Balance in charge
  - b. Using the UART command: REG0x7FBB{1} (AUTOBALANCE\_IN\_CHARGE)
6. Terminate cell-balancing if the MP279x's temperature rises too high and the related bit is enabled.
  - a. Using the GUI: BMS > Configuration > General > Balancing > Stop on Hot
  - b. Using the UART command: REG0x7FBB{3} (STOP\_ON\_HOT)

## **BMS Alarms**

### ***Cell Over-Voltage (OV) Conditions***

For more details on using the UART command, see Section 5 starting on page 62.

1. Enable cell over-voltage (OV) fault protection.
  - a. Using the GUI: BMS > Configuration > OV and UV > Cell Over-Voltage > Fault Enable
  - b. Using the UART command: REG0x7FC0{1} (CELL\_OV\_FT\_EN)
2. Set the cell OV threshold. If its voltage exceeds this threshold, the cell triggers an OV protection.
  - a. Using the GUI: BMS > Configuration > OV and UV > Cell Over-Voltage > Cell OV Threshold
  - b. Using the UART command: REG0x7F85 (CELL\_OV\_THRESHOLD)
3. Set the cell OV hysteresis. If the cell voltage drops below (cell OV threshold - cell OV hysteresis), the cell OV alarm is cleared.
  - a. Using the GUI: BMS > Configuration > OV and UV > Cell Over-Voltage > Cell OV Hysteresis
  - b. Using the UART command: REG0x7F87{3:0} (CELL\_OV\_HYSTERESIS)
4. Set the cell OV deglitch value. The related cell triggers an OV condition if the cell voltage exceeds the OV threshold for the consecutive number of Slot A conversions, configured via this bit.
  - a. Using the GUI: BMS > Configuration > OV and UV > Cell Over-Voltage > Cell OV Deglitch

- b. Using the UART command: REG0x7F88{3:0} (CELL\_OV\_DEGLITCH)
5. Enable auto-recovery for a cell OV fault. If enabled, a cell OV fault is automatically cleared if the voltage drops below (cell OV threshold - cell OV hysteresis), or if a load is connected and the voltage of the cell(s) drops below the OV threshold. For more details, see the Auto-Recovery Mode (AUTO\_RECOVERY) section on page 60.
  - a. Using the GUI: BMS > Configuration > OV and UV > Cell Over-Voltage > Cell OV Fault Auto-Recovery Enable
  - b. Using the UART command: REG0x7FC2{1} (CELL\_OV\_REC\_EN)

### **Cell Under-Voltage (UV) Conditions**

For more details on using the UART command, see Section 5 starting on page 62.

1. Enable cell under-voltage (UV) fault protection.
  - a. Using the GUI: BMS > Configuration > OV and UV > Cell Under-Voltage > Fault Enable
  - b. Using the UART command: REG0x7FC0{0} (CELL\_UV\_FT\_EN)
2. Set the cell UV threshold. If its voltage drops below the threshold, the cell triggers a UV fault.
  - a. Using the GUI: BMS > Configuration > OV and UV > Cell Under-Voltage > Cell UV Threshold
  - b. Using the UART command: REG0x7F81 (CELL\_UV\_THRESHOLD)
3. Set the cell UV hysteresis. If its voltage exceeds (cell UV threshold + cell UV hysteresis), the cell UV alarm is cleared.
  - a. Using the GUI: BMS > Configuration > OV and UV > Cell Under-Voltage > Cell UV Hysteresis
  - b. Using the UART command: REG0x7F83{3:0} (CELL\_UV\_HYSTERESIS)
4. Set the cell UV deglitch value. The cell triggers a UV protection if its voltage drops below the cell UV threshold for the consecutive number of Slot A conversions, configured via this bit.
  - a. Using the GUI: BMS > Configuration > OV and UV > Cell Under-Voltage > Cell UV Deglitch
  - b. Using the UART command: REG0x7F84{3:0} (CELL\_UV\_DEGLITCH)
5. Enable auto-recovery for a cell UV fault. If enabled, the cell UV fault is automatically cleared if the cell voltage exceeds (cell UV threshold + cell UV hysteresis), or if a charger is connected and the voltage of the cell(s) exceed the cell UV threshold. For more details, see the Auto-Recovery Mode (AUTO\_RECOVERY) section on page 60.
  - a. Using the GUI: BMS > Configuration > OV and UV > Cell Under-Voltage > Cell UV Fault Auto-recovery Enable
  - b. Using the UART command: REG0x7FC2{0} (CELL\_UV\_REC\_EN)

### **Dead Cell Conditions**

For more details on using the UART command, see Section 5 starting on page 62.

1. Enable cell dead fault protection.
  - a. Using the GUI: BMS > Configuration > OV and UV > Cell Dead > Fault Enable
  - b. Using the UART command: REG0x7FC0{2} (CELL\_DEAD\_FT\_EN)

2. Set the dead cell threshold. If its voltage drops below this threshold, a dead cell condition is triggered.
  - a. Using the GUI: BMS > Configuration > OV and UV > Cell Dead > Cell Dead Threshold
  - b. Using the UART command: REG0x7F89 (CELL\_DEAD\_THRESHOLD)
3. Set the dead cell deglitch value. A cell triggers a dead cell condition if the cell voltage falls below the dead cell threshold for the consecutive number of Slot A conversions, configured via this bit.
  - a. Using the GUI: BMS > Configuration > OV and UV > Cell Dead > Cell Dead Deglitch
  - b. Using the UART command: REG0x7F8B{3:0} (CELL\_DEAD\_DEGLITCH)

### ***Mismatched Cell Conditions***

For more details on using the UART command, see Section 5 starting on page 62.

1. Enable the mismatched cell fault.
  - a. Using the GUI: BMS > Configuration > OV and UV > Cell Mismatch > Fault Enable
  - b. Using the UART command: REG0x7FC1{5} (CELL\_MSMT\_FT\_EN)
2. Set the mismatched cell threshold. If the voltage difference between cells exceeds the mismatch cell threshold, a cell triggers a mismatch fault.
  - a. Using the GUI: BMS > Configuration > OV and UV > Cell Mismatch > Cell Mismatch Threshold
  - b. Using the UART command: REG0x7F8C{4:0} (CELL\_MSMT\_THRESHOLD)
3. Set the cell mismatch deglitch value. A cell triggers a mismatch condition if the voltage difference between this cell and any other cell exceeds the mismatch threshold for the consecutive number of Slot A conversions, configured via this bit.
  - a. Using the GUI: BMS > Configuration > OV and UV > Cell Mismatch > Cell Mismatch Deglitch
  - b. Using the UART command: REG0x7F8D{3:0} (CELL\_MSMT\_DEGLITCH)

### ***Pack Over-Voltage (OV) Conditions***

For more details on using the UART command, see Section 5 starting on page 62.

1. Enable pack over-voltage (OV) fault protection.
  - a. Using the GUI: BMS > Configuration > OV and UV > Pack Over-Voltage > Fault Enable
  - b. Using the UART command: REG0x7FC0{4} (PACK\_OV\_FT\_EN)
2. Set the pack OV threshold. If the battery voltage exceeds this threshold, a pack OV fault is triggered.
  - a. Using the GUI: BMS > Configuration > OV and UV > Pack Over-Voltage > Pack OV Threshold
  - b. Using the UART command: REG0x7F92 (PACK\_OV\_THRESHOLD)
3. Set the pack OV hysteresis. If the battery voltage falls below (pack OV threshold - pack OV hysteresis), the pack OV alarm is cleared.
  - a. Using the GUI: BMS > Configuration > OV and UV > Pack Over-Voltage > Pack OV Hysteresis
  - b. Using the UART command: REG0x7F94{5:0} (PACK\_OV\_HYSTERSIS)
4. Set the pack OV deglitch value. Pack OV fault protection is triggered if the battery voltage exceeds the pack OV threshold for the consecutive number of Slot A conversions, configured via this bit.
  - a. Using the GUI: BMS > Configuration > OV and UV > Pack Over-Voltage > Pack OV Deglitch
  - b. Using the UART command: REG0x7F95{3:0} (PACK\_OV\_DEGLITCH)

### **Pack Under-Voltage (UV) Conditions**

For more details on using the UART command, see Section 5 starting on page 62.

1. Enable pack under-voltage (UV) fault protection.
  - a. Using the GUI: BMS > Configuration > OV and UV > Pack Under-Voltage > Fault Enable
  - b. Using the UART command: REG0x7FC0{3} (PACK\_UV\_FT\_EN)
2. Set the pack UV threshold. If the battery voltage drops below this threshold, a pack UV fault is triggered.
  - a. Using the GUI: BMS > Configuration > OV and UV > Pack Under-Voltage > Pack UV Threshold
  - b. Using the UART command: REG0x7F8E (PACK\_UV\_THRESHOLD)
3. Set the pack UV hysteresis. If the battery voltage exceeds (pack UV threshold + pack UV hysteresis), the pack UV alarm is cleared.
  - a. Using the GUI: BMS > Configuration > OV and UV > Pack Under-Voltage > Pack UV Hysteresis
  - b. Using the UART command: REG0x7F90{5:0} (PACK\_UV\_HYSTERESIS)
4. Set the pack UV deglitch value. Pack UV fault protection is triggered if the battery voltage falls below the pack UV threshold for the consecutive number of Slot A conversions, configured via this bit.
  - a. Using the GUI: BMS > Configuration > OV and UV > Pack Under-Voltage > Pack UV Deglitch
  - b. Using the UART command: REG0x7F91{3:0} (PACK\_UV\_DEGLITCH)

### **Charge Over-Current (OC) Conditions**

For more details on using the UART command, see Section 5 starting on page 62.

1. Enable charge over-current (OC) fault protection.
  - a. Using the GUI: BMS > Configuration > OC and SC > Charge Over-Current > Fault Enable
  - b. Using the UART command: REG0x7FC0{7} (CHARGE\_OVERCURRENT\_FT\_EN)
2. Set the charge OC threshold. If the charge current exceeds this threshold, a charge OC fault is triggered.
  - a. Using the GUI: BMS > Configuration > OC and SC > Charge Over-Current > Charge OC Threshold
  - b. Using the UART command: REG0x7F9E (CHARGE\_OC\_THRESHOLD)
3. Set the charge OC deglitch value. If the charge current exceeds the OC threshold for the specified deglitch time, charge OC fault protection is triggered.
  - a. Using the GUI: BMS > Configuration > OC and SC > Charge Over-Current > Charge OC Deglitch time
  - b. Using the UART command: REG0x7FA0{11:0} (CHARGE\_OC\_DEGLITCH\_TIME)
4. Enable auto-recovery for a charge OC Fault. If enabled, the charge OC fault automatically clears itself if the OC condition is removed. If the condition is not removed, a FET driver fault may occur. For more details, see the Auto-Recovery Mode (AUTO\_RECOVERY) section on page 60.
  - a. Using the GUI: BMS > Configuration > OC and SC > Charge Over-Current > Charge Over-Current Fault Auto-Recovery Enable
  - b. Using the UART command: REG0x7FC2{4} (CHARGE\_OVERCURRENT\_REC\_EN)

### **Discharge Over-Current (OC) Conditions**

For more details on using the UART command, see Section 5 starting on page 62.

There are two discharge over-current (OC) fault protections (discharge OC 1 and discharge OC 2), described below. These conditions have different thresholds and deglitch times that can trigger the discharge OC alarm.

#### **Discharge OC 1**

1. Enable discharge OC 1 fault protection.
  - a. Using the GUI: BMS > Configuration > OC and SC > Discharge Over-Current 1 > Fault Enable
  - b. Using the UART command: REG0x7FC0{5} (DISCHARGE\_OVERCURRENT\_1\_FT\_EN)
2. Set the discharge OC 1 threshold. If the discharge current exceeds this threshold, a discharge OC 1 fault is triggered.
  - a. Using the GUI: BMS > Configuration > OC and SC > Discharge Over-Current 1 > Discharge OC 1 Threshold
  - b. Using the UART command: REG0x7F96 (DISCHARGE\_OC\_1\_THRESHOLD)
3. Set the discharge OC 1 deglitch time. If the discharge current exceeds its threshold for the specified deglitch time, a discharge OC 1 fault is triggered.
  - a. Using the GUI: BMS > Configuration > OC and SC > Discharge Over-Current 1 > Discharge OC 1 Deglitch Time
  - b. Using the UART command: REG0x7F98{11:0} (DISCHARGE\_OC\_1\_DEGLITCH\_TIME)
4. Enable auto-recovery for discharge OC 1 fault protection. If enabled, a discharge OC 1 fault is automatically cleared if the OC condition is removed. If this condition is not removed, a FET driver fault may occur. For more details, see the Auto-Recovery Mode (AUTO\_RECOVERY) section on page 60.
  - a. Using the GUI: BMS > Configuration > OC and SC > Discharge Over-Current 1 > Discharge Overcurrent 1 Fault Auto-Recovery Enabled
  - b. Using the UART command: REG0x7FC2{2} (DISCHARGE\_OVERCURRENT\_1\_REC\_EN)

#### **Discharge OC 2**

1. Enable discharge OC 2 fault protection.
  - a. Using the GUI: BMS > Configuration > OC and SC > Discharge Over-Current 2 > Fault Enable
  - b. Using the UART command: REG0x7FC0{6} (DISCHARGE\_OVERCURRENT\_2\_FT\_EN)
2. Set the discharge OC 2 threshold. If the discharge current exceeds this threshold, a discharge OC 2 fault is triggered.
  - a. Using the GUI: BMS > Configuration > OC and SC > Discharge Over-Current 2 > Discharge OC 2 Threshold
  - b. Using the UART command: REG0x7F9A (DISCHARGE\_OC\_2\_THRESHOLD)
3. Set the discharge OC 2 deglitch time. If the discharge current exceeds its threshold for the specified deglitch time, a discharge OC 2 fault is triggered.
  - a. Using the GUI: BMS > Configuration > OC and SC > Discharge Over-Current 2 > Discharge OC 2 Deglitch Time
  - b. Using the UART command: REG0x7F9C{11:0} (DISCHARGE\_OC\_2\_DEGLITCH\_TIME)

4. Enable auto-recovery for discharge OC 2 fault protection. If enabled, a discharge OC 2 fault is automatically cleared if the OC condition is removed. If this condition is not removed, a FET driver fault may occur. For more details, see the Auto-Recovery Mode (AUTO\_RECOVERY) section on page 60.
  - a. Using the GUI: BMS > Configuration > OC and SC > Discharge Over-Current 2 > Discharge Overcurrent 2 Fault Auto-Recovery Enabled
  - b. Using the UART command: REG0x7FC2{3} (DISCHARGE\_OVERCURRENT\_2\_REC\_EN)

### **Charge Mode Short-Circuit (SC) Conditions**

For more details on using the UART command, see Section 5 starting on page 62.

1. Enable charge mode short-circuit (SC) fault protection.
  - a. Using the GUI: BMS > Configuration > OC and SC > Charge Short Circuit > Fault Enable
  - b. Using the UART command: REG0x7FC1{1} (CHARGE\_SHORT\_CIRCUIT\_FT\_EN)
2. Set the charge mode SC threshold. If the charge current exceeds this threshold, charge mode SC fault protection is triggered.
  - a. Using the GUI: BMS > Configuration > OC and SC > Charge Short Circuit > Charge SC Threshold
  - b. Using the UART command: REG0x7FA5 (CHARGE\_SC\_THRESHOLD)
3. Set the charge mode SC deglitch time. If the charge current exceeds the charge SC threshold for the specified deglitch time, charge SC fault protection is triggered.
  - a. Using the GUI: BMS > Configuration > OC and SC > Charge Short Circuit > Charge SC Deglitch time
  - b. Using the UART command: REG0x7FA7 (CHARGE\_SC\_DEGLITCH\_TIME)
4. Enable auto-recovery for a charge mode SC fault. If enabled, a charge SC fault is automatically cleared is the SC condition is removed. If the condition is not removed, a FET driver fault may occur. For more details, see the Auto-Recovery Mode (AUTO\_RECOVERY) section on page 60.
  - a. Using the GUI: BMS > Configuration > OC and SC > Charge Short Circuit > Charge Short Circuit Fault Auto-Recovery Enable
  - b. Using the UART command: REG0x7FC2{6} (CHARGE\_SHORT\_CIRCUIT\_REC\_EN)

### **Discharge Mode Short-Circuit (SC) Conditions**

For more details on using the UART command, see Section 5 starting on page 62.

1. Enable discharge mode SC fault protection.
  - a. Using the GUI: BMS > Configuration > OC and SC > Discharge Short Circuit > Fault Enable
  - b. Using the UART command: REG0x7FC1{1} (DISCHARGE\_SHORT\_CIRCUIT\_FT\_EN). See Section 5 on page 62.
2. Set the discharge mode SC threshold. If the discharge current exceeds this threshold, discharge mode SC fault protection is triggered.
  - a. Using the GUI: BMS > Configuration > OC and SC > Charge Short Circuit > Discharge SC Threshold
  - b. Using the UART command: REG0x7FA2 (DISCHARGE\_SC\_THRESHOLD)
3. Set the discharge mode SC deglitch time. If the discharge current exceeds the discharge SC threshold for the specified deglitch time, discharge SC fault protection is triggered.

- a. Using the GUI: BMS > Configuration > OC and SC > Discharge Short Circuit > Discharge SC Deglitch time
  - b. Using the UART command: REG0x7FA4 (DISCHARGE\_SC\_DEGLITCH\_TIME). See Section 5 on page 62.
4. Enable auto-recovery for a discharge mode SC fault. If enabled, a discharge SC fault is automatically cleared is the SC condition is removed. If the condition is not removed, a FET driver fault may occur. For more details, see the Auto-Recovery Mode (AUTO\_RECOVERY) section on page 60.
- a. Using the GUI: BMS > Configuration > OC and SC > Discharge Short Circuit > Discharge Short Circuit Fault Auto-Recovery Enable
  - b. Using the UART command: REG0x7FC2{5} (DISCHARGE\_SHORT\_CIRCUIT\_REC\_EN)

### **Analog Front-End (AFE) Over-Temperature (OT) Conditions**

The MP279x over-temperature protection (OTP) function is always enabled. If OTP occurs, the protection FETs open.

### **Cell Over-Temperature (OT) Conditions**

There are two different OT thresholds (for both charge and discharge mode), described below.

For these thresholds, ensure that the NTC beta values are set correctly. Via the UART command, this is REG0x7FB8 (BETA\_BATTERY\_NTC). Via the GUI, it is BMS > Configuration > Temperature Protections > Cell Over-Temperature > Others > Beta Battery NTC.

The hysteresis is the same for both cell charge OT protection and discharge OT, and charge under-temperature (UT) protections. They also have the same auto-recovery function.

For more details on using the UART command, see Section 5 starting on page 62.

1. Enable cell OT fault protection.
  - a. Using the GUI: BMS > Configuration > Temperature Protections > Cell Over-Temperature > Fault Enable
  - b. Using the UART command: REG0x7FC1{2} (CELL\_OT\_FT\_EN)

### **Discharge Cell OT Conditions**

1. Set the cell's discharge mode OT threshold. If the current reaches the discharge threshold and the sensor reports that a temperature exceeds the OT threshold, discharge OTP is triggered.
  - a. Using the GUI: BMS > Configuration > Temperature Protections > Cell Over-Temperature > Discharge Cell OT Threshold
  - b. Using the UART command: REG0x7FA8 (DISCHARGE\_CELL\_OT\_THRESHOLD)

### **Charge Cell OT Conditions**

1. Set the cell's charge mode OT threshold. If the current reaches the discharge threshold and the sensor reports that a temperature exceeds the OT threshold, charge OTP is triggered.
  - a. Using the GUI: BMS > Configuration > Temperature Protections > Cell Over-Temperature > Charge Cell OT Threshold
  - b. Using the UART command: REG0x7FAA (CHARGE\_CELL\_OT\_THRESHOLD)
2. Set the hysteresis for both cell OT and UT protection.
  - a. Using the GUI: BMS > Configuration > Temperature Protections > Cell Over-Temperature > Cell OT-UT Hysteresis



- b. Using the UART command: REG0x7FB0{4:0} (CELL\_OT-UT\_HYSTERESIS)
3. Enable auto-recovery for cell OT protection. If enabled, a cell OT fault is cleared if the sensor's temperature drops below (cell OT threshold - cell OT/UT hysteresis). If a charge mode cell OT fault is triggered, the fault can also be cleared by disconnecting the charger and letting the temperature drop below (MIN\_CELL\_OT\_THRESHOLD - cell OT-UT hysteresis). Where MIN\_CELL\_OT\_THRESHOLD is the minimum temperature between the OT thresholds. For more details, see the Auto-Recovery Mode (AUTO\_RECOVERY) section on page 60.
  - a. Using the GUI: BMS > Configuration > Temperature Protections > Cell Over-Temperature > Cell OT/UT Fault Auto-Recovery Enable
  - b. Using the UART command: REG0x7FC2{7} (CELL\_OTUT\_REC\_EN)

### **Cell Under-Temperature (UT) Conditions**

There are two different UT thresholds (one for charge and discharge mode), described below.

For these thresholds, ensure that the NTC beta values are set correctly. Via the UART command, this is REG0x7FB6 (BETA\_BATTERY\_NTC). Via the GUI, it is BMS > Configuration > Temperature Protections > Cell Over-Temperature > Others > Beta Battery NTC.

The hysteresis is the same for both cell charge UT protection and discharge UT, and charge OT protections.

For more details on using the UART command, see Section 5 starting on page 62.

1. Enable cell UT fault protection.
  - a. Using the GUI: BMS > Configuration > Temperature Protections > Cell Under-Temperature > Fault Enable
  - b. Using the UART command: REG0x7FC1{3} (CELL\_UT\_FT\_EN)

### **Discharge Cell UT Conditions**

1. Set the cell discharge mode UT threshold. If the current reaches the discharge levels and a sensor reports a temperature below the threshold, a discharge mode UT fault is triggered.
  - a. Using the GUI: BMS > Configuration > Temperature Protections > Cell Under-Temperature > Discharge Cell UT Threshold
  - b. Using the UART command: REG0x7FAC (DISCHARGE\_CELL\_UT\_THRESHOLD)

### **Charge Cell UT Conditions**

1. Set the cell charge mode UT threshold. If the current reaches the charge levels and a sensor reports a temperature below the threshold, a charge mode UT fault is triggered.
  - a. Using the GUI: BMS > Configuration > Temperature Protections > Cell Under-Temperature > Charge Cell UT Threshold
  - b. Using the UART command: REG0x7FAE (CHARGE\_CELL\_UT\_THRESHOLD)
2. Set the hysteresis for both cell OT and UT fault protection.
  - a. Using the GUI: BMS > Configuration > Temperature Protections > Cell Under-Temperature > Cell OT-UT Hysteresis
  - b. Using the UART command: REG0x7FB0{4:0} (CELL\_OT-UT\_HYSTERESIS)
3. Enable auto-recovery for cell UT fault protection. If enabled, a cell UT fault is automatically cleared if the temperature of the sensor exceeds (cell UT threshold - cell OT/UT hysteresis). The fault can also be cleared by disconnecting the charger and letting the temperature exceeds

(MAX\_CELL\_UT\_THRESHOLD + cell OT/UT hysteresis). Where MAX\_CELL\_UT\_THRESHOLD is the maximum temperature between the charge/discharge mode UT thresholds. For more details, see the Auto-Recovery Mode (AUTO\_RECOVERY) section on page 60.

- a. Using the GUI: BMS > Configuration > Temperature Protections > Cell Over-Temperature > Cell OT/UT Fault Auto-Recovery Enable
- b. Using the UART command: REG0x7FC2{7} (CELL\_OTUT\_REC\_EN)

### **PCB Over-Temperature (OT) Conditions**

For more details on using the UART command, see Section 5 starting on page 62.

1. Enable PCB over-temperature (OT) fault protection.
  - a. Using the GUI: BMS > Configuration > Temperature Protections > PCB Over-Temperature > Fault Enable
  - b. Using the UART command: REG0x7FC1{4} (PCB\_OT\_FT\_EN)
2. Set the PCB OT threshold. An alarm is triggered if the on-board temperature sensor reports a temperature exceeding this threshold.
  - a. Using the GUI: BMS > Configuration > Temperature Protections > PCB Over-Temperature > PCB OT Threshold
  - b. Using the UART command: REG0x7FB1 (PCB\_OT\_THRESHOLD)
3. Set the hysteresis for PCB OT fault protection.
  - a. Using the GUI: BMS > Configuration > Temperature Protections > PCB Over-Temperature > PCB OT Hysteresis
  - b. Using the UART command: REG0x7FB3{4:0} (PCB\_OT\_HYSTERESIS)

### **Open-Wire Conditions**

The open-wire alarm is always active when open-wire detection is enabled. When open-wire detection is enabled, the MP279x triggers this feature every 10s while the BMS is in safe or alarm mode. The device detects and reports and detected open-wire cell connections.

For more details on using the UART command, see Section 5 starting on page 62.

1. Enable open-wire detection.
  - a. Using the GUI: BMS > Configuration > General > Others > Features Enable > Enable Open-Wire Detection
  - b. Using the UART command: REG0x7FC4{0} (ENABLE\_OPEN\_WIRE\_DETECTION)

### **FET Driver Error**

The FET driver error is always active. If the FET cannot get sufficiently close to the safe operation area (SOA) (e.g. due to a short circuit on the BMS), this fault is triggered.

### **System Error**

The system error is always active, and is triggered if there are communication failures between the MCU and the MP279x, if the MP279x reports a failure in the 3.3V supply, or if there is another internal issue.

### **Sense Error**

The sense error is active if the MP279x's ADC self-test is enabled. If the MP279x detects an issue in the ADC reference voltage for the ADC, this error is triggered.

For more details on using the UART command, see Section 5 starting on page 62.

1. Enable the sense error.
  - a. Using the GUI: BMS > Configuration > General > Others > Features Enable > Enable ADC Self-Test
  - b. Using the UART command: REG0x7FC4{6} (ENABLE\_ADC\_SELF\_TEST)

## **BMS States**

### ***Wake-Up Mode (WAKE\_UP)***

WAKE\_UP is an intermediate state during which the protection FETs are closed under discharge conditions.

### ***Wake-Up Charge Mode (WAKE\_UP\_CHG)***

WAKE\_UP\_CHG is an intermediate state during which the protection FETs are closed under charge conditions.

### ***Charge Mode (CHG)***

CHG indicates that the BMS is in an active state (the CHG and DSG FETs are closed), the protection FETs are closed, and the current is within the charge levels. A hysteresis is applied to the change between CHG and DCHG states, so a CHG state may be active even with small discharge currents.

### ***Discharge Mode (DCHG)***

DCHG indicates that the BMS is in an active state (the CHG and DSG FETs are closed), the protection FETs are closed, and the current is within the discharge levels. A hysteresis is applied to the change between DCHG and CHG states, so a DCHG state may be active even with small charge currents.

### ***Standby Mode (STAND\_BY)***

STAND\_BY indicates that the BMS has been configured to have the lowest possible current consumption.

When the MP279x enters standby mode, the MCU disables the MPF4279x and then enters sleep mode. The MP279x can still detect alarms in standby mode. If an alarm is triggered, the device wakes up the MCU and the BMS transitions to the alarm state.

If the P-channel MOSFET is enabled during standby mode (ENABLE\_PFET\_IN\_STANDBY\_MODE), then the SBY\_DSG FET remains closed while the BMS is in standby mode. If a discharge current is detected, the board automatically exits standby mode and transitions to DCHG mode. First the CHG and DSG FETs are close, then the SBY\_DSG FET is opened.

### ***Alarm Mode (ALARM)***

ALARM indicates that the protections are opened because an enabled alarm has been triggered.

If open-wire detection is enabled (ENABLE\_OPEN\_WIRE\_DETECTION), it is triggered every 10s.

To exit an alarm state, no alarms can be active, and a command must be sent to put the board to sleep (standby mode) or trigger safe mode. Then the latched alarm is released and the BMS transitions to the requested state. Note that the command is ignored if the alarm condition is still active.

### ***Safe Mode (SAFE)***

SAFE indicates that the protections are open and no alarm has been triggered. In this state, the board stays awake and takes measurements.

If open-wire detection is enabled (ENABLE\_OPEN\_WIRE\_DETECTION), it is triggered every 10s.

For more details on using the UART command, see Section 5 starting on page 62.

1. The BMS automatically transitions to the WAKE\_UP state if a load connection is detected and the dedicated bit is enabled.
  - a. Using the GUI: BMS > Configuration > General > Others > Features Enable > Enable Load Detection
  - b. Using the UART command: REG0x7FC4{1} (ENABLE\_LOAD\_DETECTION).
2. The BMS automatically transitions to the WAKE\_UP\_CHG state if a charger connection is detected and the dedicated bit is enabled.
  - a. Using the GUI: BMS > Configuration > General > Others > Features Enable > Enable Charger Detection
  - b. Using the UART command: REG0x7FC4{2} (ENABLE\_CHARGER\_DETECTION)

If none of these features are enabled, then load/charger detection is disabled and the only way to return to an ACTIVE state is to send the SAFE command.

### **Reset Alarm Mode (RESET\_ALARM)**

RESET\_ALARM indicates an intermediate state during which the alarms are reset.

### **Auto-Recovery Mode (AUTO\_RECOVERY)**

The AUTO\_RECOVERY state is an alternative to the ALARM state. This state can only be activated if all applicable faults have enabled the auto-recovery function. In this scenario, the faults do not latch-off, and the fault can also be cleared if the fault condition is removed.

The transition to this state occurs automatically and depends on the fault that was triggered. If a fault that does not have the auto-recovery function (or has this function disabled) is triggered, the BMS enters alarm mode and all active faults are latched, even if auto-recovery is enabled for an individual fault.

### **Watchdog Timer Reset**

The MP279x's watchdog function is always enabled. It is triggered every 1s that the device does not receive any write commands from the MCU. If the watchdog reset bit is enabled and the timer runs out, the MP279x forces the MCU to be reset.

For more details on using the UART command, see Section 5 starting on page 62.

1. Enable the watchdog reset function.
  - a. Using the GUI: BMS > Configuration > General > Others > Features Enable > Enable Watchdog Reset
  - b. Using the UART command: REG0x7FC4{5} (ENABLE\_WATCHDOG\_RESET)

### **Automatic Entry to Sleep (STAND\_BY) Mode**

For more details on using the UART command, see Section 5 starting on page 62.

2. Enable the auto-sleep function.
  - a. Using the GUI: BMS > Configuration > General > Standby Mode > Enable Automatic Standby Mode Entry
  - b. Using the UART command: REG0x7FC4{3} (ENABLE\_AUTOSBY)
2. Set the current threshold for automatic entry to sleep mode.
  - a. Using the GUI: BMS > Configuration > General > Standby Mode > Standby Current Threshold
  - b. Using the UART command: REG0x7FBF (STANDBY\_CURRENT\_THRESHOLD)

3. Set the time frame for which the current must be below the standby current threshold. If the current is below the threshold for this time, the device transitions to the STAND\_BY state.
  - a. Using the GUI: BMS > Configuration > General > Standby Mode > Time to Auto-Standby Entry
  - b. Using the UART command: REG0x7FBD (TIME\_TO\_STANDBY)

## Section 5. UART Protocol

### 5.1 UART Protocol

The EVBMU1xx-R-00A has a UART interface for the GUI. It follows the standard UART protocol with the following conditions:

- Data size: 8 bits
- Stop bits: 1
- Baud Rate: 115200
- Parity: None

Figure 66, Figure 67 and Figure 68 on page 63, and Figure 69 on page 64 show the dedicated protocol for the EVBMU1xx-R-00A. It also uses a CRC32/MPEG2 protocol to ensure the correct transmission in each transaction.

If there is an invalid frame/command, or a frame with the wrong CRC (either a read or a write command) being sent to the EVBMU1xx-R-00A, the response from the board is not acknowledged (NACK) (see Figure 69 on page 64).

If a valid read command is received, the EVBMU1xx-R-00A responds by sending a write command with the requested data.

If a valid write command is received, the applicable information is written to the device’s dedicated memory region, and the EVBMU1xx-R-00A should acknowledge (ACK) the transaction (see Figure 69 on page 64).

Figure 66 shows the frame format for the UART protocol.

### UART Protocol

Frame Fields

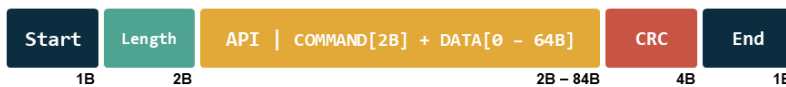

Minimum = 10 Bytes  
Maximum = 92 Bytes

- Start: 0x7e
- Length: 0–82 Bytes
- API: Command + Data
  - Command: 2 Bytes



Number of the register: 1 to 15  
R/W: 0 = Read, 1 = Write

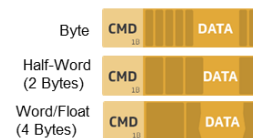

- Data: 0-82 Bytes
- CRC: CRC32/MPEG2 settings
- End: 0x0A

**Figure 66: UART Protocol (Frame Format)**

Figure 67 shows detailed examples of the UART protocol's frame format.

### UART Protocol

Data format. From Database to UART transmission/reception buffer.

- Half-Word: 16-Bit Registers

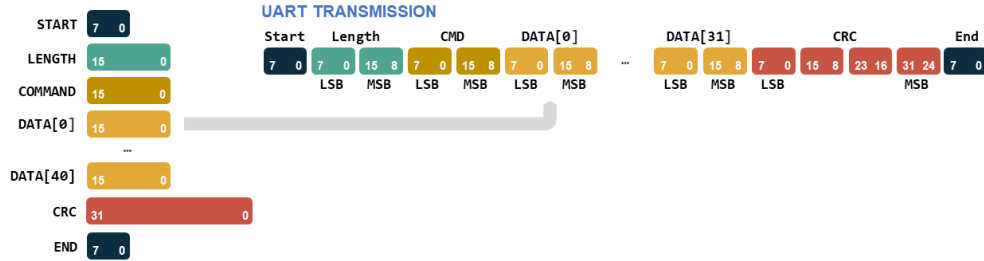

- Word/Float: 32-Bit Registers

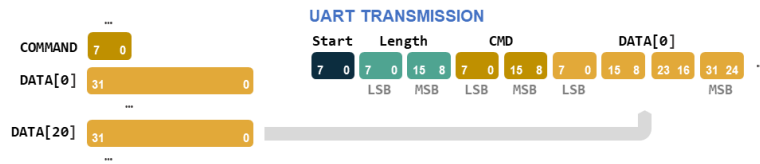
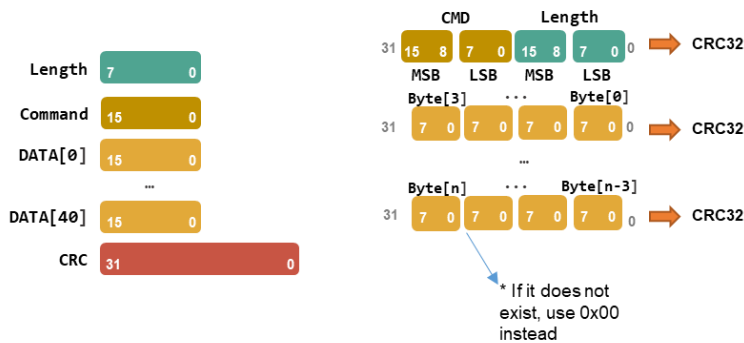

Figure 67: UART Protocol (Detailed Frame Format)

Figure 68 shows the UART protocol's CRC calculation.

### UART Protocol

CRC calculation. CRC32/MPEG2 settings.



Keep calculating CRCs for each 4-byte packet, with at least one byte present on the message.  
 Example: Length = 10. Calculate CRCs for the command and length as shown, and for Byte[0] to Byte[3], Byte[4] to Byte[7] and Byte[8] to Byte[11] using Byte[10] = Byte[11] = 0x00.

Figure 68: UART Protocol (CRC Calculation)

Figure 69 shows an acknowledge (ACK) and not acknowledge (NACK) from the UART protocol.

### UART Protocol

Acknowledge frame format and trigger events.

- ACK:  
Sent after a successful write access.

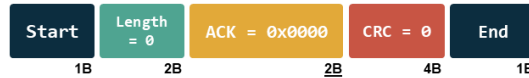

- NACK:  
Sent after an unsuccessful read/write access.



Figure 69: UART Protocol (ACK and NACK)

## 5.2 UART to I<sup>2</sup>C Communication

For the MPF4279x registers, the MCU acts as a UART to I<sup>2</sup>C connector so that the GUI can communicate with the fuel gauge. Figure 64 shows the translated messages between the UART and I<sup>2</sup>C.

### I<sup>2</sup>C Interface (Direct communication with the MPF42790)

UART vs I<sup>2</sup>C

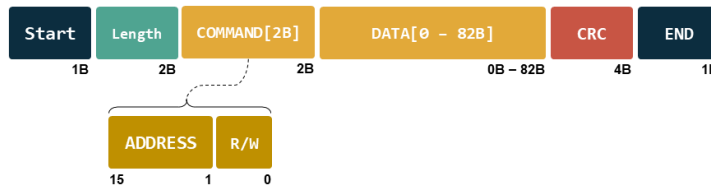

- I<sup>2</sup>C write cycle:

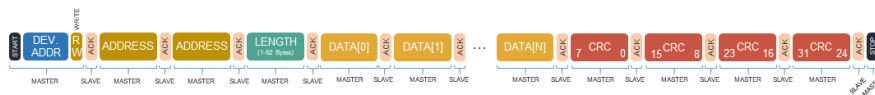

- I<sup>2</sup>C read cycle:



Figure 70: UART to I<sup>2</sup>C Communication

## 5.3 Register Map

The register map shown in this document only applies to the portions of the register map that are specific to the EVBMU1xx. The default values shown correspond with the 16-cell version. For the 14-cell and 10-cell versions, downscale the registers accordingly.

Besides the register map shown here, consider the entire register map for the MPF4279x. For more details, refer to the MPF4279x datasheet that corresponds with the fuel gauge IC used by the EVBMU1xx. The only differences are that the I<sup>2</sup>C settings can only be read, and they cannot be set. The fuel gauge input registers can only be set from the UART via the virtual fuel gauge; otherwise, they are read-only.



**BMS Data**

Name, Address	Description	Bit Length, Position	Type	Encoding	Decoded Default Value	Range
BATTERY_TOP_VOLTAGE, 0x7F00	Sets the battery top voltage, which is the voltage from the battery input to the BMS.	16, bits[15:0]	Read-only	16-bit, unsigned integer LSB = 0.002V	0	0V to 131.7V
BATTERY_TOP_CURRENT, 0x7F02	Sets the battery top current, which is the current reading that is measured simultaneously with VTOP.	32, bits[31:0]	Read-only	32-bit, signed 2-comp integer LSB = 1mA	0	-
COULOMB_COUNT_ACCUM, 0x7F06	Returns the accumulated Coulomb counter readings from the MP279x while the feature is active. For more details, see the CC_START_CMD section on page 90, the CC_RST_CMD section on page 90, and the COULOMB_COUNT_RUNNING section below).	32, bits[31:0]	Read-only	32-bit, signed 2-comp integer LSB = 0.1mAh	0	-214748364.8mAh to +214748364.7mAh
COULOMB_COUNT_TIME, 0x7F0A	Returns the time during which Coulomb counting accumulation has been active. For more details, see the COULOMB_COUNT_ACCUM section above.	30, bits[29:0]	Read-only	32-bit unsigned integer LSB = 1s	0	0s to 536870912s
COULOMB_COUNT_RUNNING, 0x7F0A	Reports the BMS's Coulomb counting (CC) accumulation status.  1: CC accumulation is running 0: CC accumulation is stopped	1, bit[30]	Read-only	Boolean true/false	0	0 to 1
COULOMB_COUNT_OVERFLOW, 0x7F0A	Reports if an overflow has occurred during Coulomb counting (CC) accumulation (either on the accumulation register or the time register). If an overflow occurs, this flag is set to 1 and CC accumulation stops.	1, bit[31]	Read-only	Boolean true/false	0	0 to 1
PACK_VOLTAGE, 0x7F0E	Returns the voltage reading from the BMS's pack output.	16, bits[15:0]	Read-only	16-bit, unsigned integer LSB = 0.002V	0	0V to 131.7V
FETS_TEMPERATURE, 0x7F10	Returns the sensor's temperature reading in proximity to the protection FETs.	16, bits[15:0]	Read-only	16-bit, signed 2-comp integer LSB = 0.01°C	0	-
AFE_TEMPERATURE, 0x7F12	Returns the MP279x's temperature.	16, bits[15:0]	Read-only	16-bit signed 2-comp integer LSB = 0.01°C	0	-
BMS_STATUS, 0x7F14	Returns the BMS's status.  0: Wake-up mode 1: Wake-up charge mode 2: Charge 3: Discharge 4: Standby mode (sleep) 5: Alarm mode 6: Safe mode 7: Reset alarms 8: MP279x auto-recovery mode	4, bits[3:0]	Read-only	8-bit, unsigned integer LSB = 1	0	-

SAFE, 0x7F15	Indicates whether the MP279x is in a safe state. 1: Safe state 0: Not a safe state	1, bit[0]	Read-only	Boolean true/false	0	-
STANDBY, 0x7F15	Indicates whether the MP279x is in a standby state. 1: Standby state 0: Not a standby state	1, bit[1]	Read-only	Boolean true/false	0	-
ACTIVE, 0x7F15	Indicates whether the MP279x is in active state. 1: Active state 0: Not an active state	1, bit[2]	Read-only	Boolean true/false	0	-
FAULT, 0x7F15	Indicates whether the MP279x is in a fault state. 1: Fault state 0: Not a fault state	1, bit[3]	Read-only	Boolean true/false	0	-
RECOVERY, 0x7F15	Indicates whether the MP279x is in a recovery state. 1: Recovery state 0: Not a recovery state	1, bit[4]	Read-only	Boolean true/false	0	-
DISCHARGE_ CURRENT, 0x7F15	Indicates whether the MP279x is in a discharge state. 1: The battery pack current exceeds the standby current and is negative 0: The battery pack current is within the standby threshold (or is positive)	1, bit[5]	Read-only	Boolean true/false	0	-
STANDBY_ CURRENT, 0x7F15	Indicates whether the MP279x is in a standby state. 1: The battery pack current is within the standby threshold 0: The battery pack current is not within the standby threshold	1, bit[6]	Read-only	Boolean true/false	0	-
CHARGE_ CURRENT, 0x7F15	Indicates whether the MP279x is in a charge state. 1: The battery pack current exceeds the standby threshold and is positive 0: The battery pack current is within the standby threshold (or is negative)	1, bit[7]	Read-only	Boolean true/false	0	-
CELL_OV, 0x7F16	Indicates whether there is a cell over-voltage (OV) fault forcing an alarm. 1: A fault is forcing an alarm 0: No fault is forcing an alarm	1, bit[0]	Read-only	Boolean true/false	0	-
CELL_UV, 0x7F16	Indicates whether there is a cell under-voltage (UV) fault forcing an alarm. 1: A fault is forcing an alarm 0: No fault is forcing an alarm	1, bit[1]	Read-only	Boolean true/false	0	-
CELL_DEAD, 0x7F16	Indicates whether there is a dead cell fault forcing an alarm. 1: A fault is forcing an alarm 0: No fault is forcing an alarm	1, bit[2]	Read-only	Boolean true/false	0	-

PACK_OV, 0x7F16	Indicates whether there is a pack OV fault forcing an alarm. 1: A fault is forcing an alarm 0: No fault is forcing an alarm	1, bit[3]	Read-only	Boolean true/false	0	-
PACK_UV, 0x7F16	Indicates whether there is a pack UV fault forcing an alarm. 1: A fault is forcing an alarm 0: No fault is forcing an alarm	1, bit[4]	Read-only	Boolean true/false	0	-
CHARGE_OVERCURRENT, 0x7F16	Indicates whether there is a charge over-current (OC) fault forcing an alarm. 1: A fault is forcing an alarm 0: No fault is forcing an alarm	1, bit[5]	Read-only	Boolean true/false	0	-
DISCHARGE_OVERCURRENT, 0x7F16	Indicates whether there is a discharge OC fault forcing an alarm. 1: A fault is forcing an alarm 0: No fault is forcing an alarm	1, bit[6]	Read-only	Boolean true/false	0	-
CHARGE_SHORT_CIRCUIT, 0x7F16	Indicates whether there is a charge short-circuit (SC) fault forcing an alarm. 1: A fault is forcing an alarm 0: No fault is forcing an alarm	1, bit[7]	Read-only	Boolean true/false	0	-
DISCHARGE_SHORT_CIRCUIT, 0x7F16	Indicates whether there is a discharge SC fault forcing an alarm. 1: A fault is forcing an alarm 0: No fault is forcing an alarm	1, bit[8]	Read-only	Boolean true/false	0	-
AFE_OT, 0x7F16	Indicates whether there is an analog front-end (AFE) over-temperature (OT) fault forcing an alarm. 1: A fault is forcing an alarm 0: No fault is forcing an alarm	1, bit[9]	Read-only	Boolean true/false	0	-
CELL_OT, 0x7F16	Indicates whether there is a cell OT fault forcing an alarm. 1: A fault is forcing an alarm 0: No fault is forcing an alarm	1, bit[10]	Read-only	Boolean true/false	0	-
CELL_UT, 0x7F16	Indicates whether there is a cell under-temperature (UT) fault forcing an alarm. 1: A fault is forcing an alarm 0: No fault is forcing an alarm	1, bit[11]	Read-only	Boolean true/false	0	-
PCB_OT, 0x7F16	Indicates whether there is a cell PCB fault forcing an alarm. 1: A fault is forcing an alarm 0: No fault is forcing an alarm	1, bit[12]	Read-only	Boolean true/false	0	-
OPEN_WIRE, 0x7F16	Indicates whether there is an open-wire fault forcing an alarm. 1: A fault is forcing an alarm 0: No fault is forcing an alarm	1, bit[13]	Read-only	Boolean true/false	0	-

CELL_MSMT, 0x7F16	Indicates whether there is a mismatched cell fault forcing an alarm. 1: A fault is forcing an alarm 0: No fault is forcing an alarm	1, bit[14]	Read-only	Boolean true/false	0	-
FET_DRV,VR, 0x7F16	Indicates whether there is a FET driver fault forcing an alarm. 1: A fault is forcing an alarm 0: No fault is forcing an alarm	1, bit[15]	Read-only	Boolean true/false	0	-
SYSTEM_ERROR, 0x7F16	Indicates whether there is a system error fault forcing an alarm. 1: A fault is forcing an alarm 0: No fault is forcing an alarm	1, bit[16]	Read-only	Boolean true/false	0	-
SENSE_ERROR, 0x7F16	Indicates whether there is a sense error fault forcing an alarm. 1: A fault is forcing an alarm 0: No fault is forcing an alarm	1, bit[17]	Read-only	Boolean true/false	0	-
CELL_OV_RT, 0x7F19	Indicates the real-time status for a cell over-voltage (OV) fault. 1: A fault is active 0: No fault is active	1, bit[0]	Read-only	Boolean true/false	0	-
CELL_UV_RT, 0x7F19	Indicates the real-time status for a cell under-voltage (UV) fault. 1: A fault is active 0: No fault is active	1, bit[1]	Read-only	Boolean true/false	0	-
CELL_DEAD_RT, 0x7F19	Indicates the real-time status for a dead cell fault. 1: A fault is active 0: No fault is active	1, bit[2]	Read-only	Boolean true/false	0	-
PACK_OV, 0x7F19	Indicates the real-time status for a pack OV fault. 1: A fault is active 0: No fault is active	1, bit[3]	Read-only	Boolean true/false	0	-
PACK_UV_RT, 0x7F19	Indicates the real-time status for a pack UV fault. 1: A fault is active 0: No fault is active	1, bit[4]	Read-only	Boolean true/false	0	-
CHARGE_ OVERCURRENT_ RT, 0x7F19	Indicates the real-time status for a charge over-current (OC) fault. 1: A fault is active 0: No fault is active	1, bit[5]	Read-only	Boolean true/false	0	-
DISCHARGE_ OVERCURRENT_ RT, 0x7F19	Indicates the real-time status for a discharge OC fault. 1: A fault is active 0: No fault is active	1, bit[6]	Read-only	Boolean true/false	0	-
CHARGE_ SHORT_CIRCUIT_ RT, 0x7F19	Indicates the real-time status for a charge short-circuit (SC) fault. 1: A fault is active 0: No fault is active	1, bit[7]	Read-only	Boolean true/false	0	-

DISCHARGE_SHORT_CIRCUIT_RT, 0x7F19	Indicates the real-time status for a discharge SC fault. 1: A fault is active 0: No fault is active	1, bit[8]	Read-only	Boolean true/false	0	-
AFE_OT_RT, 0x7F19	Indicates the real-time status for an AFE over-temperature (OT) fault. 1: A fault is active 0: No fault is active	1, bit[9]	Read-only	Boolean true/false	0	-
CELL_OT_RT, 0x7F19	Indicates the real-time status for a cell OT fault. 1: A fault is active 0: No fault is active	1, bit[10]	Read-only	Boolean true/false	0	-
CELL_UT_RT, 0x7F19	Indicates the real-time status for a cell under-temperature (UT) fault. 1: A fault is active 0: No fault is active	1, bit[11]	Read-only	Boolean true/false	0	-
PCB_OT_RT, 0x7F19	Indicates the real-time status for a PCB OT fault. 1: A fault is active 0: No fault is active	1, bit[12]	Read-only	Boolean true/false	0	-
OPEN_WIRE_RT, 0x7F19	Indicates the real-time status for an open-wire fault. 1: A fault is active 0: No fault is active	1, bit[13]	Read-only	Boolean true/false	0	-
CELL_MSMT_RT, 0x7F19	Indicates the real-time status for a mismatched cell fault. 1: A fault is active 0: No fault is active	1, bit[14]	Read-only	Boolean true/false	0	-
FET_DRVR_RT, 0x7F19	Indicates the real-time status for a FET driver fault. 1: A fault is active 0: No fault is active	1, bit[15]	Read-only	Boolean true/false	0	-
SYSTEM_ERROR_RT, 0x7F19	Indicates the real-time status for a system error fault. 1: A fault is active 0: No fault is active	1, bit[16]	Read-only	Boolean true/false	0	-
SENSE_ERROR_RT, 0x7F19	Indicates the real-time status for a sense error fault. 1: A fault is active 0: No fault is active	1, [17]	Read-only	Boolean true/false	0	-
CELL_16_UV, 0x7F1C	Indicates whether cell 16 is experiencing an under-voltage (UV) condition. 1: UV condition 0: No UV condition	1, bit[15]	Read-only	Boolean true/false	0	-
CELL_15_UV, 0x7F1C	Indicates whether cell 15 is experiencing a UV condition. 1: UV condition 0: No UV condition	1, bit[14]	Read-only	Boolean true/false	0	-

CELL_14_UV, 0x7F1C	Indicates whether cell 14 is experiencing a UV condition. 1: UV condition 0: No UV condition	1, bit[13]	Read-only	Boolean true/false	0	-
CELL_13_UV, 0x7F1C	Indicates whether cell 13 is experiencing a UV condition. 1: UV condition 0: No UV condition	1, bit[12]	Read-only	Boolean true/false	0	-
CELL_12_UV, 0x7F1C	Indicates whether cell 12 is experiencing a UV condition. 1: UV condition 0: No UV condition	1, bit[11]	Read-only	Boolean true/false	0	-
CELL_11_UV, 0x7F1C	Indicates whether cell 11 is experiencing a UV condition. 1: UV condition 0: No UV condition	1, bit[10]	Read-only	Boolean true/false	0	-
CELL_10_UV, 0x7F1C	Indicates whether cell 10 is experiencing a UV condition. 1: UV condition 0: No UV condition	1, bit[9]	Read-only	Boolean true/false	0	-
CELL_9_UV, 0x7F1C	Indicates whether cell 9 is experiencing a UV condition. 1: UV condition 0: No UV condition	1, bit[8]	Read-only	Boolean true/false	0	-
CELL_8_UV, 0x7F1C	Indicates whether cell 8 is experiencing a UV condition. 1: UV condition 0: No UV condition	1, bit[7]	Read-only	Boolean true/false	0	-
CELL_7_UV, 0x7F1C	Indicates whether cell 7 is experiencing a UV condition. 1: UV condition 0: No UV condition	1, bit[6]	Read-only	Boolean true/false	0	-
CELL_6_UV, 0x7F1C	Indicates whether cell 6 is experiencing a UV condition. 1: UV condition 0: No UV condition	1, bit[5]	Read-only	Boolean true/false	0	-
CELL_5_UV, 0x7F1C	Indicates whether cell 5 is experiencing a UV condition. 1: UV condition 0: No UV condition	1, bit[4]	Read-only	Boolean true/false	0	-
CELL_4_UV, 0x7F1C	Indicates whether cell 4 is experiencing a UV condition. 1: UV condition 0: No UV condition	1, bit[3]	Read-only	Boolean true/false	0	-
CELL_3_UV, 0x7F1C	Indicates whether cell 3 is experiencing a UV condition. 1: UV condition 0: No UV condition	1, bit[2]	Read-only	Boolean true/false	0	-
CELL_2_UV, 0x7F1C	Indicates whether cell 2 is experiencing a UV condition. 1: UV condition 0: No UV condition	1, bit[1]	Read-only	Boolean true/false	0	-

CELL_1_UV, 0x7F1C	Indicates whether cell 1 is experiencing a UV condition. 1: UV condition 0: No UV condition	1, bit[0]	Read-only	Boolean true/false	0	-
CELL_16_OV, 0x7F1E	Indicates whether cell 16 is experiencing an over-voltage (OV) condition. 1: OV condition 0: No OV condition	1, bit[15]	Read-only	Boolean true/false	0	-
CELL_15_OV, 0x7F1E	Indicates whether cell 15 is experiencing an OV condition. 1: OV condition 0: No OV condition	1, bit[14]	Read-only	Boolean true/false	0	-
CELL_14_OV, 0x7F1E	Indicates whether cell 14 is experiencing an OV condition. 1: OV condition 0: No OV condition	1, bit[13]	Read-only	Boolean true/false	0	-
CELL_13_OV, 0x7F1E	Indicates whether cell 13 is experiencing an OV condition. 1: OV condition 0: No OV condition	1, bit[12]	Read-only	Boolean true/false	0	-
CELL_12_OV, 0x7F1E	Indicates whether cell 12 is experiencing an OV condition. 1: OV condition 0: No OV condition	1, bit[11]	Read-only	Boolean true/false	0	-
CELL_11_OV, 0x7F1E	Indicates whether cell 11 is experiencing an OV condition. 1: OV condition 0: No OV condition	1, bit[10]	Read-only	Boolean true/false	0	-
CELL_10_OV, 0x7F1E	Indicates whether cell 10 is experiencing an OV condition. 1: OV condition 0: No OV condition	1, bit[9]	Read-only	Boolean true/false	0	-
CELL_9_OV, 0x7F1E	Indicates whether cell 9 is experiencing an OV condition. 1: OV condition 0: No OV condition	1, bit[8]	Read-only	Boolean true/false	0	-
CELL_8_OV, 0x7F1E	Indicates whether cell 8 is experiencing an OV condition. 1: OV condition 0: No OV condition	1, bit[7]	Read-only	Boolean true/false	0	-
CELL_7_OV, 0x7F1E	Indicates whether cell 7 is experiencing an OV condition. 1: OV condition 0: No OV condition	1, bit[6]	Read-only	Boolean true/false	0	-
CELL_6_OV, 0x7F1E	Indicates whether cell 6 is experiencing an OV condition. 1: OV condition 0: No OV condition	1, bit[5]	Read-only	Boolean true/false	0	-
CELL_5_OV, 0x7F1E	Indicates whether cell 5 is experiencing an OV condition. 1: OV condition 0: No OV condition	1, bit[4]	Read-only	Boolean true/false	0	-

CELL_4_OV, 0x7F1E	Indicates whether cell 4 is experiencing an OV condition. 1: OV condition 0: No OV condition	1, bit[3]	Read-only	Boolean true/false	0	-
CELL_3_OV, 0x7F1E	Indicates whether cell 3 is experiencing an OV condition. 1: OV condition 0: No OV condition	1, bit[2]	Read-only	Boolean true/false	0	-
CELL_2_OV, 0x7F1E	Indicates whether cell 2 is experiencing an OV condition. 1: OV condition 0: No OV condition	1, bit[1]	Read-only	Boolean true/false	0	-
CELL_1_OV, 0x7F1E	Indicates whether cell 1 is experiencing an OV condition. 1: OV condition 0: No OV condition	1, bit[0]	Read-only	Boolean true/false	0	-
CELL_16_DEAD, 0x7F20	Indicates whether cell 16 is dead. 1: Dead cell 0: No dead cell	1, bit[15]	Read-only	Boolean true/false	0	-
CELL_15_DEAD, 0x7F20	Indicates whether cell 15 is dead. 1: Dead cell 0: No dead cell	1, bit[14]	Read-only	Boolean true/false	0	-
CELL_14_DEAD, 0x7F20	Indicates whether cell 14 is dead. 1: Dead cell 0: No dead cell	1, bit[13]	Read-only	Boolean true/false	0	-
CELL_13_DEAD, 0x7F20	Indicates whether cell 13 is dead. 1: Dead cell 0: No dead cell	1, bit[12]	Read-only	Boolean true/false	0	-
CELL_12_DEAD, 0x7F20	Indicates whether cell 12 is dead. 1: Dead cell 0: No dead cell	1, bit[11]	Read-only	Boolean true/false	0	-
CELL_11_DEAD, 0x7F20	Indicates whether cell 11 is dead. 1: Dead cell 0: No dead cell	1, bit[10]	Read-only	Boolean true/false	0	-
CELL_10_DEAD, 0x7F20	Indicates whether cell 10 is dead. 1: Dead cell 0: No dead cell	1, bit[9]	Read-only	Boolean true/false	0	-
CELL_9_DEAD, 0x7F20	Indicates whether cell 9 is dead. 1: Dead cell 0: No dead cell	1, bit[8]	Read-only	Boolean true/false	0	-
CELL_8_DEAD, 0x7F20	Indicates whether cell 8 is dead. 1: Dead cell 0: No dead cell	1, bit[7]	Read-only	Boolean true/false	0	-
CELL_7_DEAD, 0x7F20	Indicates whether cell 7 is dead. 1: Dead cell 0: No dead cell	1, bit[6]	Read-only	Boolean true/false	0	-
CELL_6_DEAD, 0x7F20	Indicates whether cell 6 is dead. 1: Dead cell 0: No dead cell	1, bit[5]	Read-only	Boolean true/false	0	-



CELL_5_DEAD, 0x7F20	Indicates whether cell 5 is dead. 1: Dead cell 0: No dead cell	1, bit[4]	Read-only	Boolean true/false	0	-
CELL_4_DEAD, 0x7F20	Indicates whether cell 4 is dead. 1: Dead cell 0: No dead cell	1, bit[3]	Read-only	Boolean true/false	0	-
CELL_3_DEAD, 0x7F20	Indicates whether cell 3 is dead. 1: Dead cell 0: No dead cell	1, bit[2]	Read-only	Boolean true/false	0	-
CELL_2_DEAD, 0x7F20	Indicates whether cell 2 is dead. 1: Dead cell 0: No dead cell	1, bit[1]	Read-only	Boolean true/false	0	-
CELL_1_DEAD, 0x7F20	Indicates whether cell 1 is dead. 1: Dead cell 0: No dead cell	1, bit[0]	Read-only	Boolean true/false	0	-
CELL_16_MSMT, 0x7F22	Indicates whether cell 16 is experiencing a mismatch condition. 1: Mismatched 0: No mismatched cell	1, bit[15]	Read-only	Boolean true/false	0	-
CELL_15_MSMT, 0x7F22	Indicates whether cell 15 is experiencing a mismatch condition. 1: Mismatched 0: No mismatched cell	1, bit[14]	Read-only	Boolean true/false	0	-
CELL_14_MSMT, 0x7F22	Indicates whether cell 14 is experiencing a mismatch condition. 1: Mismatched 0: No mismatched cell	1, bit[13]	Read-only	Boolean true/false	0	-
CELL_13_MSMT, 0x7F22	Indicates whether cell 13 is experiencing a mismatch condition. 1: Mismatched 0: No mismatched cell	1, bit[12]	Read-only	Boolean true/false	0	-
CELL_12_MSMT, 0x7F22	Indicates whether cell 12 is experiencing a mismatch condition. 1: Mismatched 0: No mismatched cell	1, bit[11]	Read-only	Boolean true/false	0	-
CELL_11_MSMT, 0x7F22	Indicates whether cell 11 is experiencing a mismatch condition. 1: Mismatched 0: No mismatched cell	1, bit[10]	Read-only	Boolean true/false	0	-
CELL_10_MSMT, 0x7F22	Indicates whether cell 10 is experiencing a mismatch condition. 1: Mismatched 0: No mismatched cell	1, bit[9]	Read-only	Boolean true/false	0	-
CELL_9_MSMT, 0x7F22	Indicates whether cell 9 is experiencing a mismatch condition. 1: Mismatched 0: No mismatched cell	1, bit[8]	Read-only	Boolean true/false	0	-
CELL_8_MSMT, 0x7F22	Indicates whether cell 8 is experiencing a mismatch condition. 1: Mismatched 0: No mismatched cell	1, bit[7]	Read-only	Boolean true/false	0	-

CELL_7_MSMT, 0x7F22	Indicates whether cell 7 is experiencing a mismatch condition. 1: Mismatched 0: No mismatched cell	1, bit[6]	Read-only	Boolean true/false	0	-
CELL_6_MSMT, 0x7F22	Indicates whether cell 6 is experiencing a mismatch condition. 1: Mismatched 0: No mismatched cell	1, bit[5]	Read-only	Boolean true/false	0	-
CELL_5_MSMT, 0x7F22	Indicates whether cell 5 is experiencing a mismatch condition. 1: Mismatched 0: No mismatched cell	1, bit[4]	Read-only	Boolean true/false	0	-
CELL_4_MSMT, 0x7F22	Indicates whether cell 4 is experiencing a mismatch condition. 1: Mismatched 0: No mismatched cell	1, bit[3]	Read-only	Boolean true/false	0	-
CELL_3_MSMT, 0x7F22	Indicates whether cell 3 is experiencing a mismatch condition. 1: Mismatched 0: No mismatched cell	1, bit[2]	Read-only	Boolean true/false	0	-
CELL_2_MSMT, 0x7F22	Indicates whether cell 2 is experiencing a mismatch condition. 1: Mismatched 0: No mismatched cell	1, bit[1]	Read-only	Boolean true/false	0	-
CELL_1_MSMT, 0x7F22	Indicates whether cell 1 is experiencing a mismatch condition. 1: Mismatched 0: No mismatched cell	1, bit[0]	Read-only	Boolean true/false	0	-
CELL_MSMT_ LOWER, 0x7F24	Reports the ID of the cell with the lowest voltage.	4, bits[13:10]	Read-only	8-bit, unsigned integer LSB = 1 Offset = 1	1	1 to 16
CELL_MSMT_ DELTA, 0x7F24	Indicates the difference between the lowest and highest cell voltages.	10, bits[9:0]	Read-only	16-bit, unsigned integer LSB = 4.8828125mV	0	0mV to 4995.1171875 mV
CELL_MSMT_ STATUS, 0x7F24	This register reports whether the difference between the highest and lowest cell voltage exceeds the mismatched cell threshold. 1: The difference exceeds the threshold 0: The difference does not exceed the threshold	1, bit[14]	Read-only	Boolean true/false	0	0 to 1
AFE_OT, 0x7F26	Indicates whether the AFE is experiencing an over-temperature (OT) fault. 1: The AFE is in an OT condition 0: No OT condition for the AFE	1, bit[7]	Read-only	Boolean true/false	0	-
NTC4(PCB)_OT, 0x7F26	Indicates whether NTC4 (the PCB) is experiencing an OT fault. 1: The PCB is in an OT condition 0: No OT condition for the PCB	1, bit[6]	Read-only	Boolean true/false	0	-

NTC3_UT, 0x7F26	Indicates whether NTC3 is experiencing an under-temperature (UT) fault. 1: NTC3 is in an UT condition 0: No UT condition for NTC3	1, bit[5]	Read-only	Boolean true/false	0	-
NTC2_UT, 0x7F26	Indicates whether NTC2 is experiencing a UT fault. 1: NTC2 is in an UT condition 0: No UT condition for NTC2	1, bit[4]	Read-only	Boolean true/false	0	-
NTC1_UT, 0x7F26	Indicates whether NTC1 is experiencing a UT fault. 1: NTC2 is in an UT condition 0: No UT condition for NTC1	1, bit[3]	Read-only	Boolean true/false	0	-
NTC3_OT, 0x7F26	Indicates whether NTC3 is experiencing an OT fault. 1: NTC3 is in an OT condition 0: No OT condition for NTC3	1, bit[2]	Read-only	Boolean true/false	0	-
NTC2_OT, 0x7F26	Indicates whether NTC2 is experiencing an OT fault. 1: NTC2 is in an OT condition 0: No OT condition for NTC2	1, bit[1]	Read-only	Boolean true/false	0	-
NTC1_OT, 0x7F26	Indicates whether NTC1 is experiencing an OT fault. 1: NTC1 is in an OT condition 0: No OT condition for NTC1	1, bit[0]	Read-only	Boolean true/false	0	-
CELL_16_OWD, 0x7F27	Indicates whether there is an open wire on cell 16. 1: Open wire 0: No open wire	1, bit[16]	Read-only	Boolean true/false	0	-
CELL_15_OWD, 0x7F27	Indicates whether there is an open wire on cell 15. 1: Open wire 0: No open wire	1, bit[15]	Read-only	Boolean true/false	0	-
CELL_14_OWD, 0x7F27	Indicates whether there is an open wire on cell 14. 1: Open wire 0: No open wire	1, bit[14]	Read-only	Boolean true/false	0	-
CELL_13_OWD, 0x7F27	Indicates whether there is an open wire on cell 13. 1: Open wire 0: No open wire	1, bit[13]	Read-only	Boolean true/false	0	-
CELL_12_OWD, 0x7F27	Indicates whether there is an open wire on cell 12. 1: Open wire 0: No open wire	1, bit[12]	Read-only	Boolean true/false	0	-
CELL_11_OWD, 0x7F27	Indicates whether there is an open wire on cell 11. 1: Open wire 0: No open wire	1, bit[11]	Read-only	Boolean true/false	0	-
CELL_10_OWD, 0x7F27	Indicates whether there is an open wire on cell 10. 1: Open wire 0: No open wire	1, bit[10]	Read-only	Boolean true/false	0	-

CELL_9_OWD, 0x7F27	Indicates whether there is an open wire on cell 8. 1: Open wire 0: No open wire	1, bit[9]	Read-only	Boolean true/false	0	-
CELL_8_OWD, 0x7F27	Indicates whether there is an open wire on cell 8. 1: Open wire 0: No open wire	1, bit[8]	Read-only	Boolean true/false	0	-
CELL_7_OWD, 0x7F27	Indicates whether there is an open wire on cell 7. 1: Open wire 0: No open wire	1, bit[7]	Read-only	Boolean true/false	0	-
CELL_6_OWD, 0x7F27	Indicates whether there is an open wire on cell 6. 1: Open wire 0: No open wire	1, bit[6]	Read-only	Boolean true/false	0	-
CELL_5_OWD, 0x7F27	Indicates whether there is an open wire on cell 5. 1: Open wire 0: No open wire	1, bit[5]	Read-only	Boolean true/false	0	-
CELL_4_OWD, 0x7F27	Indicates whether there is an open wire on cell 4. 1: Open wire 0: No open wire	1, bit[4]	Read-only	Boolean true/false	0	-
CELL_3_OWD, 0x7F27	Indicates whether there is an open wire on cell 3. 1: Open wire 0: No open wire	1, bit[3]	Read-only	Boolean true/false	0	-
CELL_2_OWD, 0x7F27	Indicates whether there is an open wire on cell 2. 1: Open wire 0: No open wire	1, bit[2]	Read-only	Boolean true/false	0	-
CELL_1_OWD, 0x7F27	Indicates whether there is an open wire on cell 1. 1: Open wire 0: No open wire	1, bit[1]	Read-only	Boolean true/false	0	-
CELL_0_OWD, 0x7F27	Indicates whether there is an open wire on cell 0 (the negative pole of cell 1). 1: Open wire 0: No open wire	1, bit[0]	Read-only	Boolean true/false	0	-
CELL_OWD_RUNNING, 0x7F27	Indicates whether cell open-wire detection is working. 1: Cell open-wire detection runs periodically 0: No cell open-wire detection	1, bit[23]	Read-only	Boolean true/false	0	-
CHARGE_PUMP_STATE, 0x7F2A	Indicates the charge pump state. 1: The charge pump is on 0: The charge pump is off	1, bit[7]	Read-only	Boolean true/false	0	-
SBYDSG_FET_DRIVER_STATE, 0x7F2A	Indicates the state of the SBYDSG FET driver. 1: The driver is changing states 0: The driver is settled (off or at the target voltage)	1, bit[6]	Read-only	Boolean true/false	0	-

DSG_FET_DRIVER_STATE, 0x7F2A	Indicates the state of the DSG FET driver. 1: The driver is changing states 0: The driver is settled (off or at the target voltage)	1, bit[5]	Read-only	Boolean true/false	0	-
CHG_FET_DRIVER_STATE, 0x7F2A	Indicates the state of the CHG FET driver. 1: The driver is changing states 0: The driver is settled (off or at the target voltage)	1, bit[4]	Read-only	Boolean true/false	0	-
FET_TIMEOUT, 0x7F2A	Indicates whether a FET timeout has been detected. 1: A FET turn-on timeout has been detected 0: No timeout detected	1, bit[3]	Read-only	Boolean true/false	0	-
STANDBY_DISCHARGE_FET_ON, 0x7F2A	Indicates whether the SBYDSG FET is on. 1: On 0: Off	1, bit[2]	Read-only	Boolean true/false	0	-
DISCHARGE_FET_ON, 0x7F2A	Indicates whether the DSG FET is on. 1: On 0: Off	1, bit[1]	Read-only	Boolean true/false	0	-
CHARGE_FET_ON, 0x7F2A	Indicates whether the CHG FET is on. 1: On 0: Off	1, bit[0]	Read-only	Boolean true/false	0	-
OTP_CRC_STATUS, 0x7F2B	Indicates the one-time programmable (OTP) memory CRC status. 1: Failure detected 0: No failure detected	1, bit[6]	Read-only	Boolean true/false	0	-
OTP_CRC_CHECK_STATUS, 0x7F2B	Indicates the OTP CRC check status. 1: OTP CRC check is done 0: No OTP CRC check is done	1, bit[5]	Read-only	Boolean true/false	0	-
VDD_STATUS, 0x7F2B	Indicates the VDD status. 1: Failure detected 0: No failure detected	1, bit[4]	Read-only	Boolean true/false	0	-
3V3_STATUS, 0x7F2B	Indicates the 3V3 status. 1: Failure detected 0: No failure detected	1, bit[3]	Read-only	Boolean true/false	0	-
REGIN_STATUS, 0x7F2B	Indicates the REGIN status. 1: Failure detected 0: No failure detected	1, bit[2]	Read-only	Boolean true/false	0	-
SELF_TEST_OV, 0x7F2B	Indicates the over-voltage (OV) self-test status. 1: Failure detected 0: No failure detected	1, bit[1]	Read-only	Boolean true/false	0	-
SELF_TEST_UV, 0x7F2B	Indicates the under-voltage (UV) self-test status. 1: Failure detected 0: No failure detected	1, bit[0]	Read-only	Boolean true/false	0	-

CHARGER_PLUGIN_DETECTED, 0x7F2C	Indicates whether the charger plugin has been detected. 1: Detected 0: Not detected	1, bit[15]	Read-only	Boolean true/false	0	-
LOAD_PLUGIN_DETECTED, 0x7F2C	Indicates whether the load plugin has been detected. 1: Detected 0: Not detected	1, bit[14]	Read-only	Boolean true/false	0	-
CHARGER_DETECTION_FAILED, 0x7F2C	Indicates whether charger detection failed. 1: The charger connection is settling and the capacitor cannot reach $V_{TOP} + 100mV$ 0: No charger settling error	1, bit[13]	Read-only	Boolean true/false	0	-
LOAD_DETECTION_FAILED, 0x7F2C	Indicates whether load detection has failed. 1: The load connection is settling and the capacitor cannot reach $V_{TOP} - 1V$ 0: No load connection error	1, bit[12]	Read-only	Boolean true/false	0	-
CHARGE_VOLTAGE, 0x7F2C	Indicates the charge voltage. 1: The PACKP voltage exceeds $V_{TOP}$ by 100mV 0: This condition has not been met	1, bit[10]	Read-only	Boolean true/false	0	-
STANDBY_VOLTAGE, 0x7F2C	Indicates the standby voltage. 1: The PACKP voltage is close to $V_{TOP}$ ( $V_{TOP} + 100mV$ and $> V_{TOP} - 1V$ ) 0: This condition has not been met	1, bit[9]	Read-only	Boolean true/false	0	-
DISCHARGE_VOLTAGE, 0x7F2C	Indicates the discharge voltage. 1: The PACKP voltage is 1V below $V_{TOP}$ 0: This condition has not been met	1, bit[8]	Read-only	Boolean true/false	0	-
CHARGER_DETECTION_ENGAGED, 0x7F2C	Indicates whether charger detection is active. 1: Charger detection is active. The pre-charge capacitor waits to detect a charger 0: Charger detection is not active	1, bit[5]	Read-only	Boolean true/false	0	-
PRECHARGE_FET_STATE, 0x7F2C	Indicates the pre-charge FET state. 1: The pre-charge FET is closed 0: The pre-charge FET is open	1, bit[7]	Read-only	Boolean true/false	0	-
LOAD_DETECTION_ENGAGED, 0x7F2C	Indicates whether load detection is active. 1: Load detection is active. The pre-charge capacitor waits to detect a load 0: Load detection is not active	1, bit[4]	Read-only	Boolean true/false	0	-

CHARGER_DETECTION_SETTLING, 0x7F2C	Indicates the charger detection settling.  1: The charger connection is settling, and the capacitor is reaching $V_{TOP}$ . The state machine for charger connection is enabled. The pull-up current is enabled but the pack voltage has not reached $V_{TOP}$ 0: The device is not in this state	1, bit[3]	Read-only	Boolean true/false	0	-
LOAD_DETECTION_SETTLING, 0x7F2C	Indicates whether load detection is settling.  1: The load connection is settling, and the capacitor is reaching $V_{TOP}$ 0: This condition has not been met	1, bit[2]	Read-only	Boolean true/false	0	-
CHARGER_DETECTION_ENABLE, 0x7F2C	Indicates whether charger detection is enabled.  1: Charger connection detection is enabled (PACKP is pulled above $V_{TOP} + 100mV$ ) 0: Charger detection is not enabled	1, bit[1]	Read-only	Boolean true/false	0	-
PLUGIN_ENABLE, 0x7F2C	Indicates whether plugin is enabled.  1: Load connection detection is enabled (PACKP is pulled below $V_{TOP} - 1V$ ) 0: Load detection is not enabled	1, bit[0]	Read-only	Boolean true/false	0	-
BAL_ACTIVE, 0x7F2E	Indicates whether balancing is active.	1, bit[0]	Read-only	Boolean true/false	0	0 to 1
VSCAN_DONE_INTERRUPT_COUNTER, 0x7F30	Counts the number of times the $V_{SCAN}$ done interrupt has been triggered.	32, bits[31:0]	Read-only	32-bit, unsigned integer LSB = 1	0	0 to 4294967295
WATCHDOG_INTERRUPT_COUNTER, 0x7F34	Counts the number of times the watchdog interrupt has been triggered.	16, bits[15:0]	Read-only	16-bit, unsigned integer LSB = 1	0	0 to 65535
AFE_MODE_CHANGE_INTERRUPT_COUNTER, 0x7F36	Counts the number of times the AFE mode change interrupt has been triggered.	16, bits[15:0]	Read-only	16-bit, unsigned integer LSB = 1	0	0 to 65535
PACK_CURRENT_INTERRUPT_COUNTER, 0x7F38	Counts the number of times the pack current interrupt has been triggered.	16, bits[15:0]	Read-only	16-bit, unsigned integer LSB = 1	0	0 to 65535
LOAD_AND_CHARGER_DETECTION_INTERRUPT_COUNTER, 0x7F3A	Counts the number of times the load and charger interrupt has been triggered.	16, bits[15:0]	Read-only	16-bit, unsigned integer LSB = 1	0	0 to 65535

**BMS Configurations**

Name, Address	Description	Bit Length, Position	Type	Encoding	Decoded Default Value	Range
NUMBER_OF_STACKED_CELLS, 0x7F80	Returns the number of stacked cells in the battery pack.	5, bits[4:0]	R/W	8-bit, unsigned integer LSB = 1	16	7 to 16
CELL_UV_THRESHOLD, 0x7F81	Sets the threshold for cell under-voltage (UV) fault protection.	16, bits[15:0]	R/W	16-bit, unsigned integer LSB = 0.1mV	3000	0mV to 4980.5mV
CELL_UV_HYSTERESIS, 0x7F83	Sets the hysteresis for cell UV fault protection.	4, bits[3:0]	R/W	8-bit, unsigned integer LSB = 19.53125mV	19.53125	0mV to 292.96875mV
CELL_UV_DEGLITCH, 0x7F84	Sets the deglitch value for cell UV fault protection. This sets the number of consecutive readings that are required to trigger a cell UV fault protection.	4, bits[3:0]	R/W	8-bit, unsigned integer LSB = 1 Offset = 1	2	1 to 16
CELL_OV_THRESHOLD, 0x7F85	Sets the threshold for cell over-voltage (OV) fault protection.	16, bits[15:0]	R/W	16-bit, unsigned integer LSB = 0.1mV	4200	0mV to 4980.5 mV
CELL_OV_HYSTERESIS, 0x7F87	Sets the hysteresis for cell OV fault protection.	4, bits[3:0]	R/W	8-bit, unsigned integer LSB = 19.53125mV	19.53125	0mV to 292.96875mV
CELL_OV_DEGLITCH, 0x7F88	Sets the deglitch value for cell OV fault protection. This sets the number of consecutive readings that are required to trigger a cell OV fault protection.	4, bits[3:0]	R/W	8-bit, unsigned integer LSB = 1 Offset = 1	2	1 to 16
CELL_DEAD_THRESHOLD, 0x7F89	Sets the dead cell threshold.	16, bits[15:0]	R/W	16-bit, unsigned integer LSB = 0.1mV	2000	0mV to 2480.4mV
CELL_DEAD_DEGLITCH, 0x7F8B	Sets the dead cell deglitch value, which is the number of consecutive readings required to trigger a dead cell fault.	4, bits[3:0]	R/W	8-bit, unsigned integer LSB = 1 Offset = 1	2	1 to 16
CELL_MSMT_THRESHOLD, 0x7F8C	Sets the mismatched cell threshold.	5, bits[4:0]	R/W	8-bit, unsigned integer LSB = 39.0625mV	117.1875	0mV to 1210.9375mV
CELL_MSMT_DEGLITCH, 0x7F8D	Sets the mismatched cell deglitch value, which is the number of consecutive readings required to trigger a mismatched cell fault.	4, bits[3:0]	R/W	8-bit, unsigned integer LSB = 1 Offset = 1	2	1 to 16
PACK_UV_THRESHOLD, 0x7F8E	Sets the threshold for pack under-voltage (UV) fault protection.	16, bits[15:0]	R/W	16-bit, unsigned integer LSB = 2mV	48800	0mV to 79982mV
PACK_UV_HYSTERESIS, 0x7F90	Sets the hysteresis for pack UV fault protection.	6, bits[5:0]	R/W	8-bit, unsigned integer LSB = 78.125mV	234.375	0mV to 4921.875mV



PACK_UV_DEGLITCH, 0x7F91	Sets the deglitch value for pack UV fault protection. This sets the number of consecutive readings that are required to trigger a pack UV fault protection.	4, bits[3:0]	R/W	8-bit, unsigned integer LSB = 1 Offset = 1	2	1 to 16
PACK_OV_THRESHOLD, 0x7F92	Sets the threshold for pack over-voltage (OV) fault protection.	16, bits[15:0]	R/W	16-bit, unsigned integer LSB = 2mV	66800	0mV to 79982mV
PACK_OV_HYSTERESIS, 0x7F94	Sets the hysteresis for pack OV fault protection.	6, bits[5:0]	R/W	8-bit, unsigned integer LSB = 78.125mV	234.375	0mV to 4921.875mV
PACK_OV_DEGLITCH, 0x7F95	Sets the deglitch value for pack OV fault protection. This sets the number of consecutive readings that are required to trigger a pack OV fault protection.	4, bits[3:0]	R/W	8-bit, unsigned integer LSB = 1 Offset = 1	2	1 to 16
DISCHARGE_OC_1_THRESHOLD, 0x7F96	<p>Sets the threshold for discharge over-current (OC) 1 fault protection. The actual resolution is limited by the MP279x, which was a resolution of 2.5mV until 80mV, and 7.5mV up to 240mV.</p> <p>The actual resolution (in terms of current) depends on the value of the shunt resistor.</p> <p>The default 1mΩ value for the EVBMU1xx translates to 2.5A of resolution up until 80A and 7.5A for DOC configurations exceeding 80A.</p> <p>The default 0.2mΩ value for the EVBMU1xx HP translates to 12.5A of resolution for the complete allowed range for EVBMU1xx HP. The EVBMU1xx (HP) sets the DOC threshold to the closest available set point value based in the value of this register.</p>	16, bits[15:0]	R/W	16-bit, unsigned integer LSB = 2mA	15000	0mA to 131070mA
DISCHARGE_OC_1_DEGLITCH_TIME, 0x7F98	Sets the discharge OC 1 deglitch time. The current must exceed the discharge OC 1 threshold for this time to trigger a fault.	12, bits[11:0]	R/W	16-bit, unsigned integer LSB = 1ms	100	1ms to 2560ms

<p>DISCHARGE_OC_2_THRESHOLD, 0x7F9A</p>	<p>Sets the threshold for discharge OC 2 fault protection. The actual resolution is limited by the MP279x, which was a resolution of 2.5mV until 80mV, and 7.5mV up to 240mV.</p> <p>The actual resolution (in terms of current) depends on the value of the shunt resistor.</p> <p>The default 1mΩ value for the EVBMU1xx translates to 2.5A of resolution up until 80A and 7.5A for DOC configurations exceeding 80A.</p> <p>The default 0.2mΩ value for the EVBMU1xx HP translates to 12.5A of resolution for the complete allowed range for EVBMU1xx HP. The EVBMU1xx (HP) sets the DOC threshold to the closest available set point value based in the value of this register.</p>	<p>16, bits[15:0]</p>	<p>R/W</p>	<p>16-bit, unsigned integer LSB = 2mA</p>	<p>18000</p>	<p>0mA to 131070mA</p>
<p>DISCHARGE_OC_2_DEGLITCH_TIME, 0x7F9C</p>	<p>Sets the discharge OC 2 deglitch time. The current must exceed the discharge OC 1 threshold for this time to trigger a fault.</p>	<p>12, bits[11:0]</p>	<p>R/W</p>	<p>16-bit, unsigned integer LSB = 1ms</p>	<p>20</p>	<p>1ms to 2560ms</p>
<p>CHARGE_OC_THRESHOLD, 0x7F9E</p>	<p>Sets the threshold for charge OC fault protection. The actual resolution is limited by the MP279x, as it has a resolution of 1.6mV up to 51.2mV, and 4.8mV up to 153.6mV.</p> <p>The actual resolution (in terms of current) depends on the value of the shunt resistor.</p> <p>The default 1mΩ value for the EVBMU1xx translates to 1.6A of resolution up to 51.2A and 4.8A for COC configurations that exceed 51.2A.</p> <p>The default 0.2mΩ value for the EVBMU1xx HP translates to 8A of resolution for the complete range for the EVBMU1xx HP.</p> <p>The EVBMU1xx (HP) sets the COC threshold to the closest available set point value based in the value of this register.</p>	<p>16, bits[15:0]</p>	<p>R/W</p>	<p>16-bit, unsigned integer LSB = 2mA</p>	<p>7500</p>	<p>0mA to 131070mA</p>
<p>CHARGE_OC_DEGLITCH_TIME, 0x7FA0</p>	<p>Sets the charge OC deglitch time. The current must exceed the charge OC threshold for this time to trigger a fault.</p>	<p>12, bits[11:0]</p>	<p>R/W</p>	<p>16-bit, unsigned integer LSB = 1ms</p>	<p>20</p>	<p>1ms to 2560ms</p>

DISCHARGE_SC_THRESHOLD, 0x7FA2	<p>Sets the discharge short-circuit (SC) threshold. The actual resolution is limited by the MP279x, as it has a resolution of 5.5mV up to 176mV, and 16.5mV up to 528mV.</p> <p>The actual resolution (in terms of current) depends on the value of the shunt resistor.</p> <p>The default 1mΩ value for the EVBMU1xx translates to 5.5A of resolution for the complete range for the EVBMU1xx.</p> <p>The default 0.2mΩ value for the EVBMU1xx HP translates to 16.5A of resolution for the complete allowed range for EVBMU1xx HP.</p> <p>The EVBMU1xx (HP) sets the DSC threshold to the closest available set point value based in the value of this register.</p>	16, bits[15:0]	R/W	16-bit, unsigned integer LSB = 2mA	22500	0mA to 131070mA
DISCHARGE_SC_DEGLITCH_TIME, 0x7FA4	<p>Sets the discharge SC deglitch time. The current must exceed the discharge SC threshold for this time to trigger a fault.</p>	7, bits[6:0]	R/W	8-bit, unsigned integer LSB = 20μs	200	1μs to 25400μs
CHARGE_SC_THRESHOLD, 0x7FA5	<p>Sets the charge short-circuit (SC) threshold. The actual resolution is limited by the MP279x, as it has a resolution of 2.5mV up to 80mV, and 7.5mV up to 240mV.</p> <p>The actual resolution (in terms of current) depends on the value of the shunt resistor.</p> <p>The default 1mΩ value for the EVBMU1xx translates to 2.5A of resolution up until 80A, and 7.5A for CSC configurations exceeding 80A.</p> <p>The default 0.2mΩ value for the EVBMU1xx HP translates to 12.5A of resolution for the complete allowed range for EVBMU1xx HP.</p> <p>The EVBMU1xx (HP) sets the CSC threshold to the closest available set point value based in the value of this register.</p>	16, bits[15:0]	R/W	16-bit, unsigned integer LSB = 2mA	9375	0mA to 131070mA
CHARGE_SC_DEGLITCH_TIME, 0x7FA7	<p>Sets the charge SC deglitch time. The current must exceed the discharge SC threshold for this time to trigger a fault.</p>	7, bits[6:0]	R/W	8-bit, unsigned integer LSB = 200μs	1600	1μs to 25400μs
DISCHARGE_CELL_OT_THRESHOLD, 0x7FA8	<p>Sets the discharge cell over-temperature (OT) threshold.</p>	16, bits[15:0]	R/W	16-bit, signed 2-comp integer LSB = 0.01°C	58	-273.15°C to +327.67°C
CHARGE_CELL_OT_THRESHOLD, 0x7FAA	<p>Sets the charge cell OT threshold.</p>	16, bits[15:0]	R/W	16-bit, signed 2-comp integer LSB = 0.01°C	43	-273.15°C to 327.67°C
DISCHARGE_CELL_UT_THRESHOLD, 0x7FAC	<p>Sets the discharge cell under-temperature (UT) threshold.</p>	16, bits[15:0]	R/W	16-bit, signed 2-comp integer LSB = 0.01°C	-18	-273.15°C to +327.67°C

CHARGE_CELL_UT_THRESHOLD, 0x7FAE	Sets the charge cell UT threshold.	16, bits[15:0]	R/W	16-bit, signed 2-comp integer LSB = 0.01°C	2	-273.15°C to +327.67°C
CELL_OT-UT_HYSTERESIS, 0x7FB0	Sets the cell OT and UT hysteresis.	5, bits[4:0]	R/W	8-bit, unsigned integer LSB = 6.4453125mV	12.890625	0mV to 199.8046875mV
NUM_OF_CELL_NTCS, 0x7FB0	Selects the number of cell temperature sensors in the battery. The selected channels monitor the cell temperature and can trigger cell OT or UT protection. Excluded channels are monitored but cannot trigger faults.  0 or 3: NTC1, NTC2, and NTC3 1: Only NTC1 2: NTC1 and NTC2	2, bits[6:5]	R/W	8-bit, unsigned integer LSB = 1	3	0 to 3
PCB_OT_THRESHOLD, 0x7FB1	Sets the threshold for a PCB over-temperature (OT) fault protection.	16, bits[15:0]	R/W	16-bit, signed 2-comp integer LSB = 0.01°C	85	-273.15°C to +327.67°C
PCB_OT_HYSTERESIS, 0x7FB3	Sets the hysteresis for PCB OT fault protection.	5, bits[4:0]	R/W	8-bit, unsigned integer LSB = 6.4453125mV	12.890625	0mV to 199.8046875mV
CURRENT_SENSE_GAIN, 0x7FB4	Sets the current-sense gain.	16, bits[15:0]	R/W	16-bit, unsigned integer LSB = 0.0003814697265625%	100	87.5% to 112.5%
CURRENT_SENSE_OFFSET, 0x7FB6	Sets the offset that is applied to the measured current.	16, bits[15:0]	R/W	16-bit, signed 2-comp integer LSB = 1mA	0	-32768mA to +32767mA
BETA_BATTERY_NTC, 0x7FB8	Sets the beta value for the battery NTC sensors.	16, bits[15:0]	R/W	16-bit, unsigned integer LSB = 1K	3380	0K to 65535K
BALANCING_THRESHOLD, 0x7FBA	Sets the maximum allowed imbalance between two cells before cell-balancing is activated to equalize the cells.	3, bits[6:4]	R/W	8-bit, unsigned integer LSB = 9.765625mV	19.53125	19.53125mV to 87.890625mV
AUTOBALANCE_IN_CHARGE, 0x7FBA	Sets the auto-balance function in charge mode.  1: Auto-balancing can run if a charge current exceeds the charge standby threshold 0: Auto-balancing does not run	1, bit[0]	R/W	Control Enable = 1 Disable = 0	1	0 to 1
AUTOBALANCE_IN_STANDBY, 0x7FBA	Sets the auto-balance function in standby mode.  1: Auto-balancing can run if a charge current is between 0A and the standby threshold 0: Auto-balancing does not run	1, bit[1]	R/W	Control Enable = 1 Disable = 0	1	0 to 1

STOP_ON_HOT, 0x7FBA	Enables the device to stop due to a hot condition.  1: Suspend auto-balancing if the silicon digital die temperature is too hot 0: Ignore hot conditions	1, bit[3]	R/W	Control Enable = 1 Disable = 0	1	0 to 1
BALANCING_MINIMUM_VOLTAGE, 0x7FBB	Sets the minimum cell voltage to balance a cell.	16, bits[15:0]	R/W	16-bit, unsigned integer LSB = 0.1 mV	4000	2500mV to 5000mV
TIME_TO_STANDBY, 0x7FBD	If automatic standby mode entry is enabled, this register sets the time during which the current must be within the standby range before transitioning to standby/sleep mode.	16, bits[15:0]	R/W	16-bit, unsigned integer LSB = 1 s	60	0s to 65535s
STANDBY_CURRENT_THRESHOLD, 0x7FBF	Defines the standby mode current limit range. Note that to convert these voltage values to the actual current, use the shunt resistor value.	8, bits[7:0]	R/W	8-bit, unsigned integer LSB = 125µV Offset = 250µV	250	250µV to 625µV
CELL_UV_FT_EN, 0x7FC0	Enables cell under-voltage (UV) fault protection.  1: Enabled 0: Disabled	1, bit[0]	R/W	Control Enable = 1 Disable = 0	1	-
CELL_OV_FT_EN, 0x7FC0	Enables cell over-voltage (OV) fault protection.  1: Enabled 0: Disabled	1, bit[1]	R/W	Control Enable = 1 Disable = 0	1	-
CELL_DEAD_FT_EN, 0x7FC0	Enables dead cell fault protection.  1: Enabled 0: Disabled	1, bit[2]	R/W	Control Enable = 1 Disable = 0	1	-
PACK_UV_FT_EN, 0x7FC0	Enables pack UV fault protection.  1: Enabled 0: Disabled	1, bit[3]	R/W	Control Enable = 1 Disable = 0	1	-
PACK_OV_FT_EN, 0x7FC0	Enables pack OV fault protection.  1: Enabled 0: Disabled	1, bit[4]	R/W	Control Enable = 1 Disable = 0	1	-
DISCHARGE_OVERCURRENT_1_FT_EN, 0x7FC0	Enables discharge over-current (OC) 1 fault protection.  1: Enabled 0: Disabled	1, bit[5]	R/W	Control Enable = 1 Disable = 0	1	-
DISCHARGE_OVERCURRENT_2_FT_EN, 0x7FC0	Enables discharge OC 2 fault protection.  1: Enabled 0: Disabled	1, bit[6]	R/W	Control Enable = 1 Disable = 0	1	-
CHARGE_OVERCURRENT_FT_EN, 0x7FC0	Enables charge OC fault protection.  1: Enabled 0: Disabled	1, bit[7]	R/W	Control Enable = 1 Disable = 0	1	-
DISCHARGE_SHORT_CIRCUIT_FT_EN, 0x7FC0	Enables discharge short-circuit (SC) fault protection.  1: Enabled 0: Disabled	1, bit[8]	R/W	Control Enable = 1 Disable = 0	1	-

CHARGE_SHORT_CIRCUIT_FT_EN, 0x7FC0	Enables charge SC fault protection. 1: Enabled 0: Disabled	1, bit[9]	R/W	Control Enable = 1 Disable = 0	1	-
CELL_OT_FT_EN, 0x7FC0	Enables cell over-temperature (OT) fault protection. 1: Enabled 0: Disabled	1, bit[10]	R/W	Control Enable = 1 Disable = 0	1	-
CELL_UT_FT_EN, 0x7FC0	Enables cell under-temperature (UT) fault protection. 1: Enabled 0: Disabled	1, bit[11]	R/W	Control Enable = 1 Disable = 0	1	-
PCB_OT_FT_EN, 0x7FC0	Enables PCB OT fault protection. 1: Enabled 0: Disabled	1, bit[12]	R/W	Control Enable = 1 Disable = 0	1	-
CELL_MSMT_FT_EN, 0x7FC0	Enables mismatched cell fault protection. 1: Enabled 0: Disabled	1, bit[13]	R/W	Control Enable = 1 Disable = 0	0	-
CELL_UV_REC_EN, 0x7FC2	Enables auto-recovery from cell under-voltage (UV) fault protection. 1: Enabled 0: Disabled	1, bit[0]	R/W	Control Enable = 1 Disable = 0	1	-
CELL_OV_REC_EN, 0x7FC2	Enables auto-recovery from cell over-voltage (OV) fault protection. 1: Enabled 0: Disabled	1, bit[1]	R/W	Control Enable = 1 Disable = 0	1	-
DISCHARGE_OVERCURRENT_1_REC_EN, 0x7FC2	Enables auto-recovery from discharge over-current (OC) 1 fault protection. 1: Enabled 0: Disabled	1, bit[2]	R/W	Control Enable = 1 Disable = 0	1	-
DISCHARGE_OVERCURRENT_2_REC_EN, 0x7FC2	Enables auto-recovery from discharge OC 2 fault protection. 1: Enabled 0: Disabled	1, bit[3]	R/W	Control Enable = 1 Disable = 0	1	-
CHARGE_OVERCURRENT_REC_EN, 0x7FC2	Enables auto-recovery from charge OC fault protection. 1: Enabled 0: Disabled	1, bit[4]	R/W	Control Enable = 1 Disable = 0	1	-
DISCHARGE_SHORT_CIRCUIT_REC_EN, 0x7FC2	Enables auto-recovery from discharge short-circuit (SC) fault protection. 1: Enabled 0: Disabled	1, bit[5]	R/W	Control Enable = 1 Disable = 0	1	-
CHARGE_SHORT_CIRCUIT_REC_EN, 0x7FC2	Enables auto-recovery from charge SC fault protection. 1: Enabled 0: Disabled	1, bit[6]	R/W	Control Enable = 1 Disable = 0	1	-

CELL_OTUT_ REC_EN, 0x7FC2	Enables auto-recovery from cell over-temperature (OT) and under-temperature (UT) fault protection. 1: Enabled 0: Disabled	1, bit[7]	R/W	Control Enable = 1 Disable = 0	1	-
PCB_OT_ REC_EN, 0x7FC2	Enables auto-recovery from PCB OT fault protection. 1: Enabled 0: Disabled	1, bit[9]	R/W	Control Enable = 1 Disable = 0	1	-
ENABLE_ BALANCING, 0x7FC4	Enables cell-balancing. 1: Enabled 0: Disabled	1, bit[7]	R/W	Control Enable = 1 Disable = 0	0	-
ENABLE_ADC_ SELF_TEST, 0x7FC4	Enables an ADC self-test. 1: The MP279x performs an ADC self-test 0: Disabled	1, bit[6]	R/W	Control Enable = 1 Disable = 0	1	-
ENABLE_ WATCHDOG_ RESET, 0x7FC4	Enables the watchdog reset function. 1: A watchdog fault resets the MCU and MP279x 0: Disabled	1, bit[5]	R/W	Control Enable = 1 Disable = 0	1	-
ENABLE_PFET_ IN_STANDBY_ MODE, 0x7FC4	Enables the SBYDSG P-channel MOSFET in standby mode. 1: The SBYDSG P-channel MOSFET is on in standby mode. If current is detected, the board automatically transitions to active mode 0: Disabled	1, bit[4]	R/W	Control Enable = 1 Disable = 0	1	-
ENABLE_ AUTOSBY, 0x7FC4	Enables the device to automatically enter standby mode. 1: The board automatically enters standby mode after a defined time if the current is within the standby range 0: Disabled	1, bit[3]	R/W	Control Enable = 1 Disable = 0	0	-
ENABLE_ LOAD_ DETECTION, 0x7FC4	Enables load detection. 1: Load detection is active in safe mode to close the protections if a load is present 0: Disabled	1, bit[2]	R/W	Control Enable = 1 Disable = 0	1	-
ENABLE_ CHARGER_ DETECTION, 0x7FC4	Enables charger detection in safe mode. 1: Charger detection is active in SAFE mode to close the protections if a charger is present 0: Disabled	1, bit[1]	R/W	Control Enable = 1 Disable = 0	1	-
ENABLE_ OPEN_WIRE_ DETECTION, 0x7FC4	Enables open-wire detection. 1: Open-wire detection is active in safe and fault mode 0: Disabled	1, bit[0]	R/W	Control Enable = 1 Disable = 0	1	-

ENABLE_SCOC_SAFE, 0x7FC4	Enables short-circuit (SC) and over-current (OC) monitoring, even when in safe mode.  1: SC and OC monitoring are available in safe mode 0 No SC and OC monitoring are available in safe mode	1, bit[8]	R/W	Control Enable = 1 Disable = 0	1	-
ENABLE_CC_AUTOSTART, 0x7FC4	Enables Coulomb counting accumulation to automatically start.  1: BMS Coulomb counting accumulation automatically starts after start-up or a BMS reset 0: BMS Coulomb counting accumulation waits for a start command	1, bit[9]	R/W	Control Enable = 1 Disable = 0	0	-

**BMS\_ID**

Name, Address	Description	Bit Length, Position	Type	Encoding	Decoded Default Value	Range
BMS_ID, 0x7FE0	Returns which BMS AFE is in use. 0h97 (151 decimal): MP2797 0h91 (145 decimal): MP2791	8, bits[7:0]	Read-only	8-bit, unsigned integer LSB = 1	0	0 to 255
HP_VERSION, 0x7FE1	Determines whether the board is a high-power version. 1: High-power version 0: Standard version	8, bits[7:0]	Read-only	8-bit, unsigned integer LSB = 1	0	0 to 1



Virtual Fuel Gauge

Name, Address	Description	Bit Length, Position	Type	Encoding	Decoded Default Value	Range
VFG_EN, 0x7FE2	<p>Enables virtual fuel gauge (VFG). This bit reports if VFG mode is enabled.</p> <p>To enable VFG mode, send a one-byte command with the value 0x01 to register 0x7FE2; writing any other value to register 0x7FE2 disables the VFG. Once the VFG is enabled, the EVBMU1xx's MCU stops its automatic control of the MPF4279x fuel gauge, and changes the FG input registers to R/W so the measurement inputs from the fuel gauge can be input from the user interface.</p> <p>While VFG mode is enabled, the FG input and output register structures can be fully read in a single transaction, instead of being restricted by the usual 82-byte maximum transaction length.</p> <p>The VFG process should follow the steps below:</p> <ol style="list-style-type: none"> <li>1. Send 0x01 to address 0x7FE2 to enable the VFG</li> <li>2. Verify that VFG_EN = 1, VFG_FIRST = 1, VFG_IT_RUNNING = 0, VFG_IT_DONE = 0, and VFG_READING = 0. If not, repeat step 1.</li> <li>3. Write the VFG input to the fuel gauge's input registers.</li> <li>4. Trigger a VFG iteration by sending an EXE_CMD command.</li> <li>5. Verify that VFG_IT_RUNNING = 1 or VFG_IT_DONE = 1. If not, repeat step 4.</li> <li>6. Wait until VFG_IT_RUNNING = 0 and VFG_IT_DONE = 1.</li> <li>7. Read the fuel gauge output.</li> <li>8. Verify that VFG_EN = 1; VFG_FIRST = 0; VFG_IT_RUNNING = 0; VFG_IT_DONE = 0 and VFG_READING = 0. If not, repeat step 7.</li> <li>9. Repeat steps 3 through 8 until the VFG test is complete.</li> <li>10. Disable the VFG</li> </ol> <p>Note: It might be of interest to add some FG resets before each Iteration if the VFG does not start on the same battery conditions as the latest Iteration the Fuel Gauge has seen.</p>	1, bit[0]	R/W	Control Enable = 1 Disable = 0	0	0 to 1

VFG_IT_RUNNING, 0x7FE2	When the virtual fuel gauge is enabled (VFG_EN = 1) this register is set to 1 while an FG iteration is ongoing. It is reset once the iteration is completed (fuel gauge completed the iteration and the results are successfully read by the MCU). The user should wait for this bit to be reset and VFG_IT_DONE to be set prior to reading the FG results for that iteration.  This register is always 0 when VFG is disabled.	1, bit[1]	Read-only	Boolean true/false	0	0 to 1
VFG_IT_DONE, 0x7FE2	When the virtual fuel gauge is enabled (VFG_EN = 1) this register is set to 1 when an FG iteration is complete (the fuel gauge completed the iteration and the results have been successfully read by the MCU). It is reset once the user interface performs a read of a portion or the entire fuel gauge output register structure. While this bit is set, no new iteration can be requested; first the FG output must be read.  This register is always 0 when the VFG is disabled.	1, bit[2]	Read-only	Non-standard	0	0 to 1
VFG_READING, 0x7FE2	When the VFG is enabled (VFG_EN = 1) this register is used internally and set while the fuel gauge output structure is being read from the FG by the MCU.  This register is always 0 when the VFG is disabled.	1, bit[3]	Read-only	Boolean true/false	0	0 to 1
VFG_FIRST, 0x7FE2	Sets when the VFG is enabled or reset when the fuel gauge input is written to the MPF4279x FG for the first time. Used internally.  This register is always 0 when the VFG is disabled.	1, bit[4]	Read-only	Boolean true/false	0	0 to 1
VFG_LAST_IT, 0x7FE3	Contains the value of the fuel gauge's FG_ITER register from the previous iteration.	32, bits[31:0]	Read-only	32-bit, unsigned integer LSB = 1	0	0 to 4294967295

### Commands

Name, Address	Description	Bit Length, Position	Type	Encoding	Decoded Default Value	Range
STANDBY_MODE, 0x7FF0	Sends a command to put the BMS in standby/sleep mode.  0x01: The BMS enters standby/sleep mode. This is a self-clearing command	1, bit[0]	Write-only	Non-standard	0x0	0 to 1
SAFE_MODE, 0x7FF1	Sends a command to put the BMS in safe mode.  0x01: The BMS enters safe mode. This is a self-clearing command	1, bit[0]	Write-only	Non-standard	0x0	0 to 1

<p>DEFAULT_CONFIGURATION, 0x7FF2</p>	<p>Sets if the BMS returns to its default configuration.</p> <p>0x01: The BMS returns to its default configuration. This is a self-clearing command</p>	<p>1, bit[0]</p>	<p>Write-only</p>	<p>Non-standard</p>	<p>0x0</p>	<p>0 to 1</p>
<p>RESET_BMS, 0x7FF3</p>	<p>Resets the BMS.</p> <p>0x01: Reset the BMS. This is a self-clearing command</p>	<p>1, bit[0]</p>	<p>Write-only</p>	<p>Non-standard</p>	<p>0x0</p>	<p>0 to 1</p>
<p>CC_START_CMD, 0x7FF4</p>	<p>Starts and stops Coulomb counting accumulation. If Coulomb counter accumulation is not running, this commands starts the function; otherwise it stops the function. See the COULOMB_COUNT_RUNNING command to check if CC is running or not.</p> <p>0x01: Toggle the CC accumulation running status. This is a self-clearing command</p>	<p>1, bit[0]</p>	<p>R/W</p>	<p>Non-standard</p>	<p>0x0</p>	<p>0 to 1</p>
<p>CC_RST_CMD, 0x7FF5</p>	<p>Resets Coulomb counter accumulation. In this scenario, COULOMB_COUNT_ACCUM, COULOMB_COUNT_TIME, and COULOMB_COUNT_OVERFLOW are set to 0.</p> <p>0x01: Reset CC accumulation. This is a self-clearing command</p>	<p>1, bit[0]</p>	<p>R/W</p>	<p>Non-standard</p>	<p>0x0</p>	<p>0 to 1</p>

## REVISION HISTORY

Revision #	Revision Date	Description	Pages Updated
1.0	5/18/2022	Initial Release	-

**Notice:** The information in this document is subject to change without notice. Please contact MPS for current specifications. Users should warrant and guarantee that third-party Intellectual Property rights are not infringed upon when integrating MPS products into any application. MPS will not assume any legal responsibility for any said applications.