



MEZS7-1S-4SPDCharger

Bidirectional PD Application with Fully Integrated Buck-Boost Charger for 1S to 4S In Series Solution Module

DESCRIPTION

The MEZS7-1S-4SPDCharger is a solution module for PD applications with the MP2760 and CCG3PA, supporting PD3.0 and BC1.2 protocols. The MP2760 is a buck-boost charger designed for battery packs with 1 cell to 4 cells in series. The device supplies a wide 3V to 21V voltage range at the IN pin in source mode. This is compliant to the USB PD specifications. The CCG3PA is a Cypress PD controller that handles the PD protocol.

The board contains a DRP Type-C port. When

an adapter is inserted, the port acts as a UFP to charge the battery with a maximum 5A charge current. When a load is inserted, the port acts as a DFP to power the USB from the battery.

The board supports narrow-voltage DC (NVDC) power path management, which makes this board well-suited for different portable applications, such as tablets, MIDs, and smartphones. Its low-impedance power path optimizes efficiency, reduces battery charging time, and extends battery life.

PERFORMANCE SUMMARY ⁽¹⁾

Specifications are at $T_A = 25^\circ\text{C}$, unless otherwise noted.

Parameters	Conditions	Value
Input voltage (V_{IN}) range		4V to 22V
Battery charge regulation voltage (V_{BATT_REG})		8.4V (I ² C-configurable)
Fast charge current	$V_{IN} = 9\text{V to }20\text{V}$	5A (I ² C-configurable)
Output voltage in source mode (V_{IN_SRC})		3V to 21V
Charge typical efficiency	$V_{IN} = 20\text{V}, V_{BATT} = 8\text{V}, I_{CC} = 5\text{A}$	93.49%
Charge peak efficiency	$V_{IN} = 12\text{V}, V_{BATT} = 8\text{V}, I_{CC} = 3\text{A}$	96%
Source mode typical efficiency	$V_{BATT} = 7.4\text{V}, V_{IN_SRC} = 20\text{V}, I_{IN_SRC} = 1.5\text{A}$	93.5%
Source mode peak efficiency	$V_{BATT} = 8.4\text{V}, V_{IN_SRC} = 12\text{V}, I_{IN_SRC} = 1.5\text{A}$	96.37%
Switching frequency (f_{sw})		600kHz (I ² C-configurable)

Note:

- 1) Refer to the MP2760 datasheet for more details.

EVALUATION BOARD

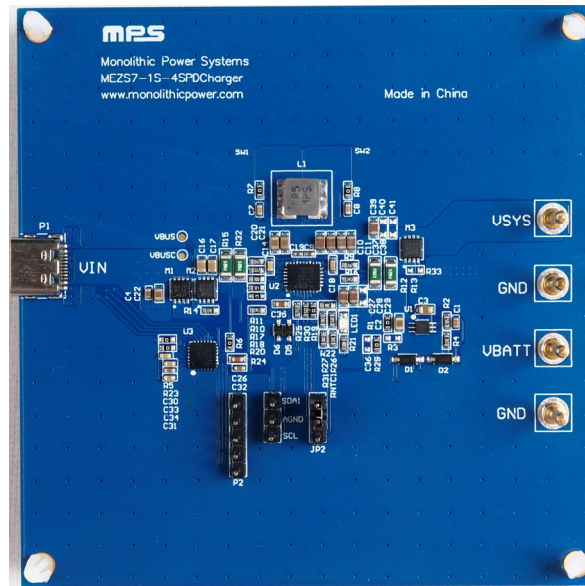

LxWxH (8.9cmx8.9cmx0.16cm)

Board Number	MPS IC Number
MEZS7-1S-4SPDCharger	MP2760GVT

QUICK START GUIDE

The MEZS7-1S-4SPDCharger is a reference design using the M2760 for PD applications, and includes a DRP Type-C port. Its layout accommodates most commonly used capacitors. The charge current is preset to 5A, and the charge-full voltage is preset to 8.4V for a Li-ion battery with 2 cells in series. In USB On-the-Go (OTG) mode, the output is preset to 5V/3A. All of the charging/discharging parameters are set by the CCG3PA. The user can download their own codes to the CCG3PA through the board's configuration header.

1. Connect the load to to:
 - a. Positive (+): VSYS
 - b. Negative (-): GND
2. Connect the battery terminal to to:
 - a. Positive (+): VBATT
 - b. Negative (-): GND
3. If using a battery simulator, preset the battery voltage between 0V and 8.4V, then turn it off. Connect the battery simulator's ports to:
 - a. Positive (+): VBATT
 - b. Negative (-): GND
4. Ensure that the battery voltage is present (if using a battery simulator, keep the simulator on).
5. For charge mode testing, connect the Type-C port to an adapter with a USB Type-C to Type-C or Type-A to Type-C cable. Charge mode should start automatically.
6. For source mode testing, connect the device to a Type-C port with a USB Type-C to Type-C, Type-C to Micro-B, or Type-C to lighting cable. Source mode should start automatically.

Figure 1 shows the measurement equipment set-up.

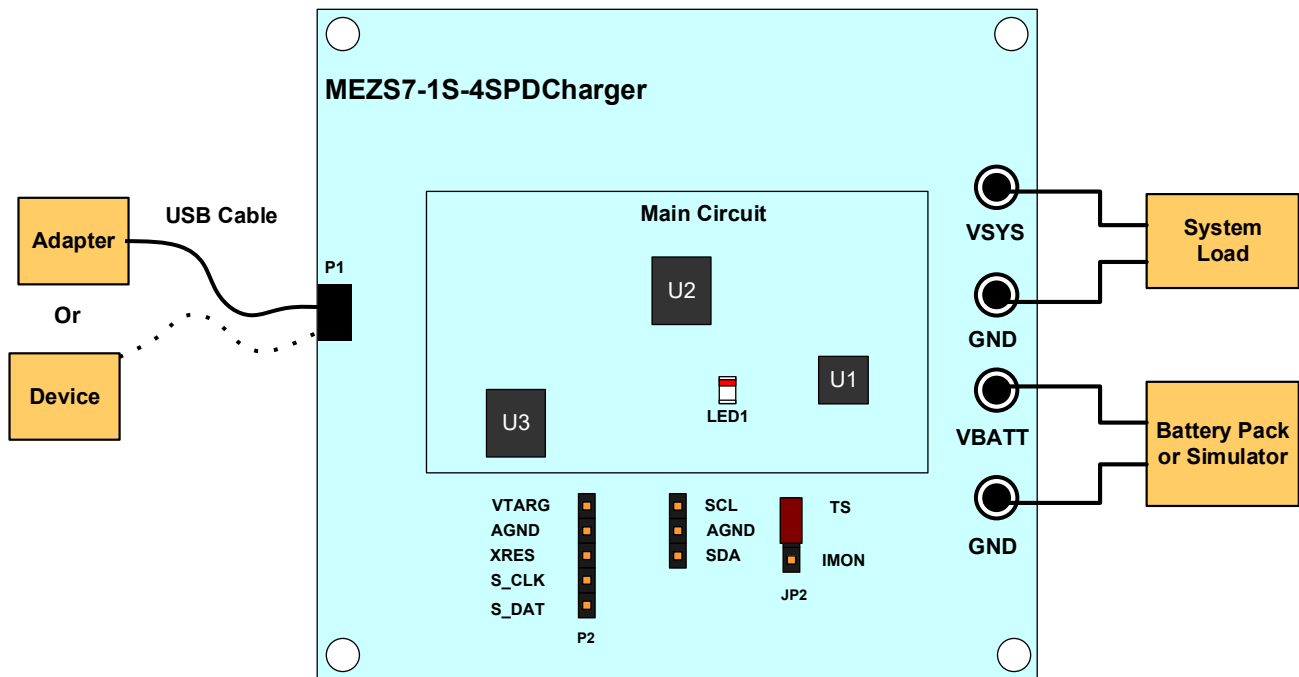

Figure 1: Measurement Equipment Set-Up

EVALUATION BOARD SCHEMATIC

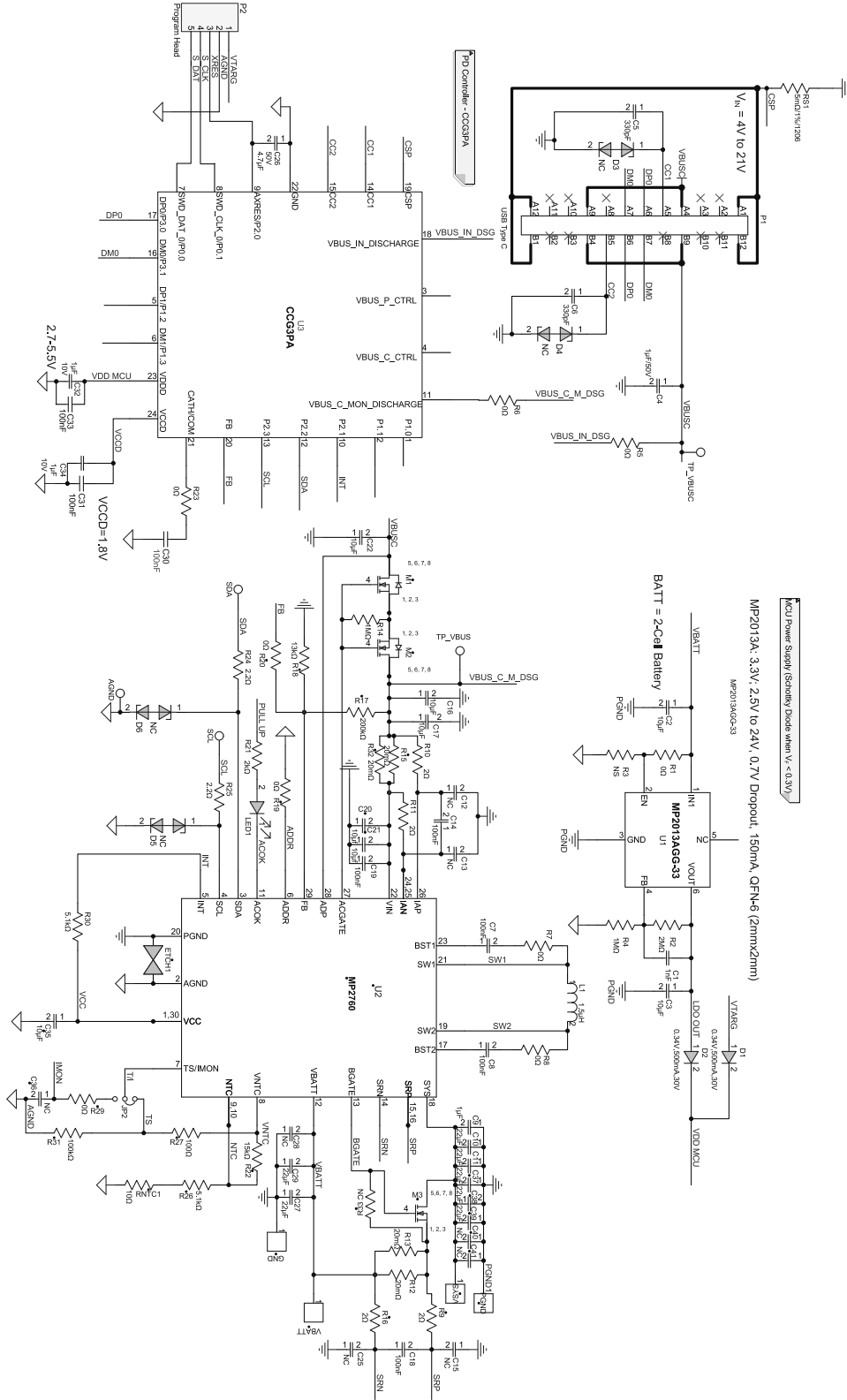

Figure 2: Evaluation Board Schematic

MEZS7-1S-4SPDCHARGER BILL OF MATERIALS

Qty	Ref	Value	Description	Package	Manufacturer	Manufacturer PN
7	C10, C11, C27, C28, C37, C38, C39	22 μ F	Ceramic capacitor, 25V, X5R	0805	Murata	GRM21BR61E226ME44L
7	C2, C3, C16, C17, C20, C21, C22	10 μ F	Ceramic capacitor, 25V, X5R	0805	Murata	GRM21BR61E106KA73
3	C4, C32, C34	1 μ F	Ceramic capacitor, 50V, X5R	0603	Murata	GRM188R61H105KAAL
2	C26, C35	4.7 μ F	Ceramic capacitor, 25V, X5R	0603	Murata	GRM188R61E475KE11D
2	C9, C19	1 μ F	Ceramic capacitor, 25V, X7R	0402	Murata	GRM155R61E105KA12
7	C7, C8, C14, C18, C30, C31, C32	100nF	Ceramic capacitor, 25V, X7R	0603	Würth	885012206071
1	C1	1nF	Ceramic capacitor, 50V, X7R	0603	TDK	C1608X7R1H102K
2	C5, C6	330pF	Ceramic capacitor, 50V, X7R	0603	Murata	GRM188R71H331KA01D
8	C12, C13, C15, C25, C36, C29, C40, C41	NC				
2	R4, R14	1M Ω	Film resistor, 1%	0603	Yageo	RC0603FR-071ML
1	R21	2k Ω	Film resistor, 1%	0603	Yageo	RC0603FR-072KL
2	R26, R30	5.1k Ω	Film resistor, 5%	0603	Yageo	RC0603JR-075K1L
9	R1, R5, R6, R7, R8, R23, R19, R20, R29	0 Ω	Film resistor, 5%	0603	Yageo	RC0603JR-070RL
1	R2	2M Ω	Film resistor, 5%	0603	Yageo	RC0603JR-072ML
1	R17	200k Ω	Film resistor, 1%	0603	Yageo	RC0603FR-07200KL
1	R18	13k Ω	Film resistor, 1%	0603	Yageo	RC0603FR-0713KL
1	R22	15k Ω	Film resistor, 1%	0603	Yageo	RC0603FR-0715KL
2	R27, R31	100k Ω	Film resistor, 5%	0603	Yageo	RC0603JR-07100KL
1	RNTC1	10k Ω	Film resistor, 1%	0603	Yageo	RC0603FR-0710KL
6	R9, R16, R10, R11, R24, R25	2 Ω	Film resistor, 5%	0603	LIZ	CR0603JA02R0G
1	RS1	5m Ω	Film resistor, 1%	1206	Yageo	PA1206FRF070R005L
4	R12, R13, R15, R32	20m Ω	Film resistor, 1%	1206	Cyntec	RL1632H-R020-FN

MEZS7-1S-4SPDCHARGER BILL OF MATERIALS (continued)

Qty	Ref	Value	Description	Package	Manufacturer	Manufacturer PN
1	P1	5A	USB Type-C connector	SMD	YaLian	93579102
3	M1, M2, M3	30V, 20A	N-channel MOSFET	PowerPAK-1212-8	Vishay	SISA14DN-T1-GE3
2	D1, D2	20V, 0.5A	Schottky diode	SOD-123	Diodes	B0520LW-7-F
4	D3, D4, D5, D6	NC				
1	LED1	Green	Green LED	0805	Bai Hong	BL-HGE35A-AV-TRB
1	U3	24.5V	PD controller	QFN-24 (4mmx4mm)	Cypress	CYPD3171-24LQXQ
1	L1	1.5 μ H	Inductor, 1.5 μ H, 9.7m Ω , 9A	SMD	MPS	MPL-AL5030-1R5
1	U1	MP2013A	LDO	QFN-6 (2mmx2mm)	MPS	MP2013AGG
1	U2	MP2760	Charger IC	TQFN-30 (4mmx5mm)	MPS	MP2760GVT-0000

SOLUTION MODULE TEST RESULTS

Performance curves and waveforms are tested on the evaluation board. $C_{IN} = 5 \times 10\mu F + 1 \times 1\mu F$, $C_{SYS} = 5 \times 22\mu F + 1 \times 1\mu F$, $C_{BATT} = 2 \times 22\mu F$, $L = 1.5\mu H$ (10mΩ), $T_A = 25^\circ C$, unless otherwise noted.

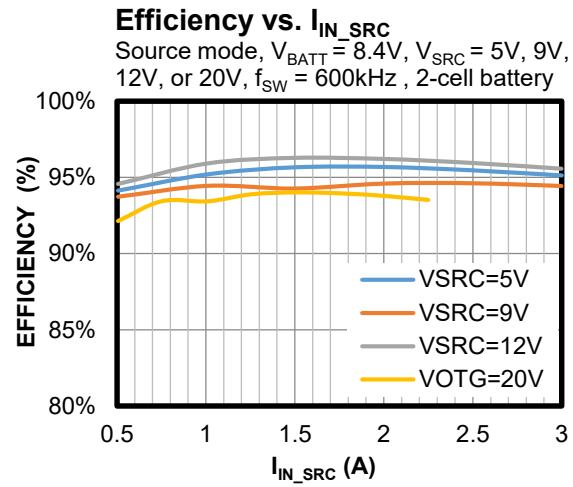
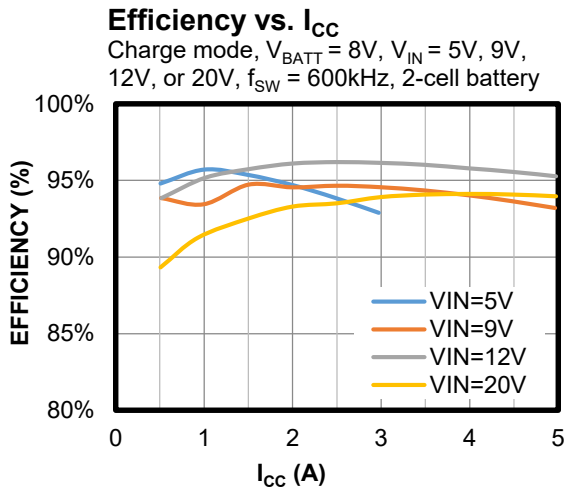

SOLUTION MODULE TEST RESULTS *(continued)*

Performance curves and waveforms are tested on the evaluation board. $C_{IN} = 5 \times 10\mu\text{F} + 1 \times 1\mu\text{F}$, $C_{SYS} = 5 \times 22\mu\text{F} + 1 \times 1\mu\text{F}$, $C_{BATT} = 2 \times 22\mu\text{F}$, $L = 1.5\mu\text{H}$ (10m Ω), $f_{SW} = 600\text{kHz}$, 2-cell battery, $T_A = 25^\circ\text{C}$, unless otherwise noted.

Thermal Performance

Charge mode, $V_{IN} = 20\text{V}$, $I_{INLIMIT} = 3\text{A}$,
 $V_{BATT} = 8.2\text{V}$, $I_{CC} = 5\text{A}$

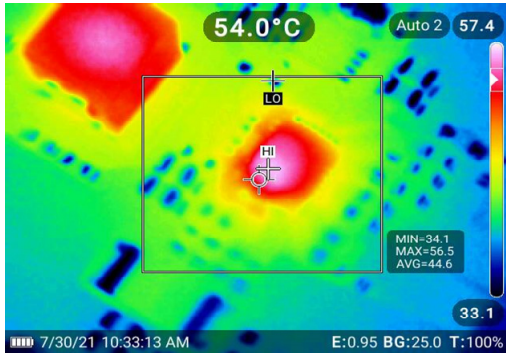

Thermal Performance

Source mode, $V_{BATT} = 8.4\text{V}$, $V_{IN_SRC} = 20\text{V}$,
 $I_{IN_SRC} = 1.8\text{A}$.

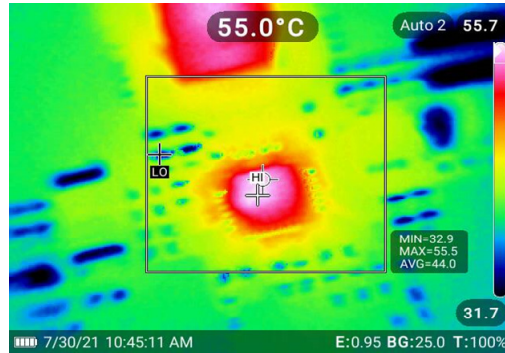

SOLUTION MODULE TEST RESULTS *(continued)*

Performance curves and waveforms are tested on the evaluation board. $C_{IN} = 5 \times 10\mu\text{F} + 1 \times 1\mu\text{F}$, $C_{SYS} = 5 \times 22\mu\text{F} + 1 \times 1\mu\text{F}$, $C_{BATT} = 2 \times 22\mu\text{F}$, $L = 1.5\mu\text{H}$ (10m Ω), $f_{SW} = 600\text{kHz}$, 2-cell battery, $T_A = 25^\circ\text{C}$, unless otherwise noted.

Sink Mode (BC 1.2)

$V_{BATT} = 7\text{V}$, $I_{CHG} = 5\text{A}$, use the USB 3.0 port as the input

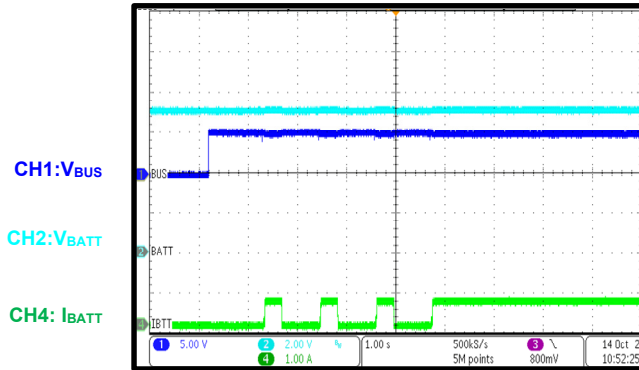

Sink Mode (PD Adapter)

$V_{BATT} = 7\text{V}$, $I_{CHG} = 5\text{A}$, use the PD adapter (max 15V/2A) as the input

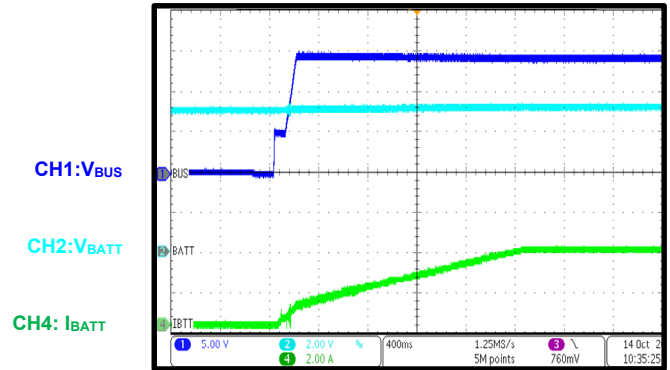

Source Mode (PD2.0)

$V_{BATT} = 8\text{V}$, $V_{OTG} = 5\text{V}$ to 9V to 12V to 15V to 20V , test with PD tester

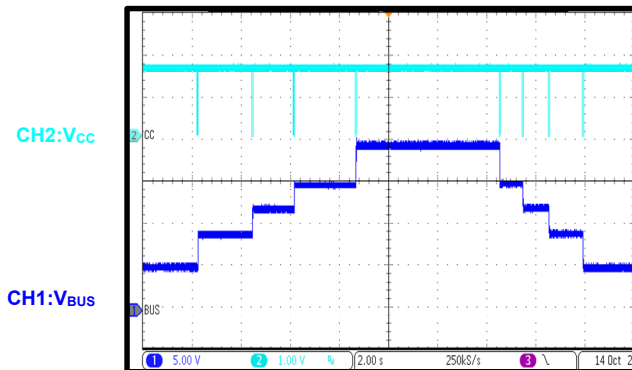

Source Mode (PD 3.0)

$V_{BATT} = 8\text{V}$, $V_{OTG} = 3.3\text{V}$ to 16V with 20mv/step, test with PD tester

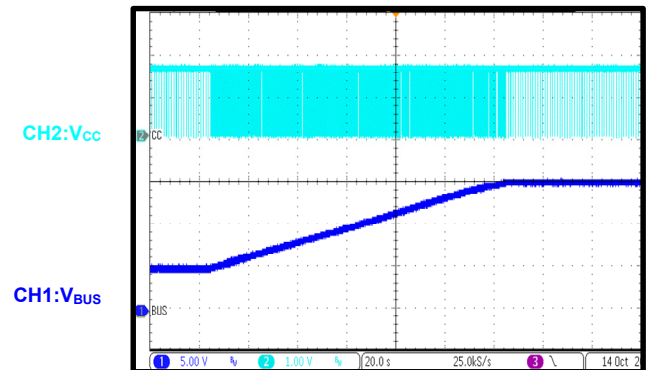

PCB LAYOUT

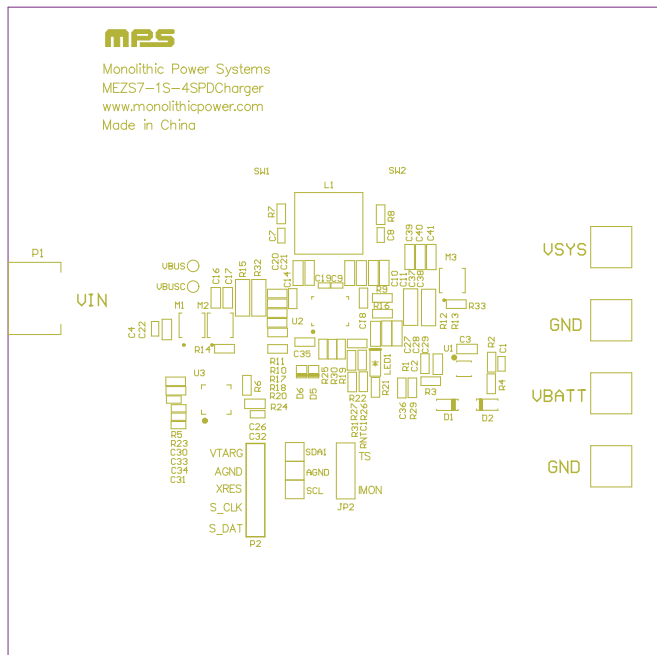

Figure 3: Top Silk

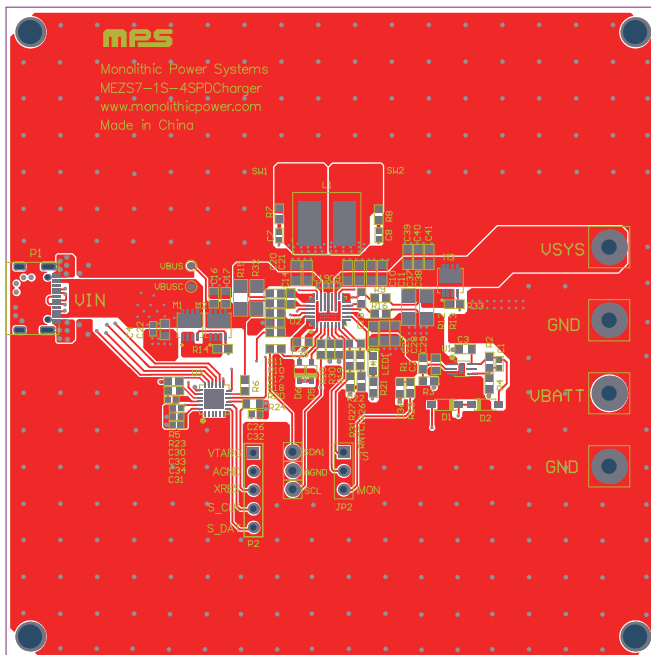

Figure 4: Top Layer

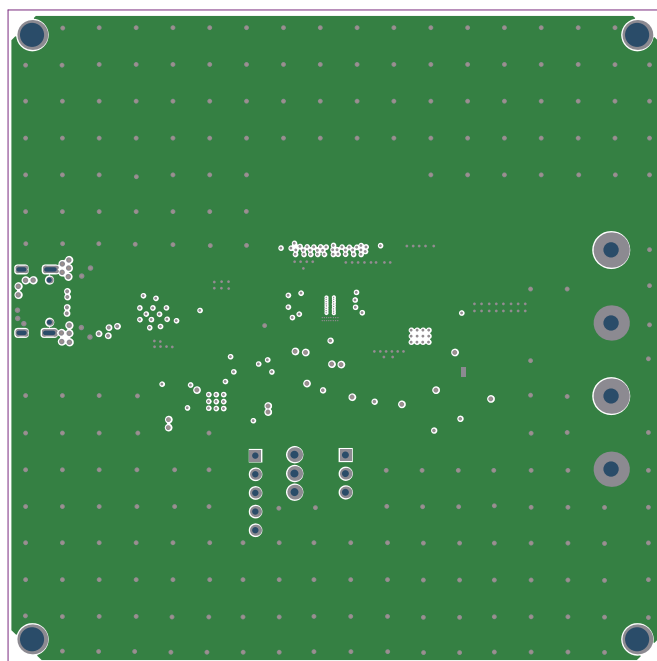

Figure 5: Mid-Layer 1

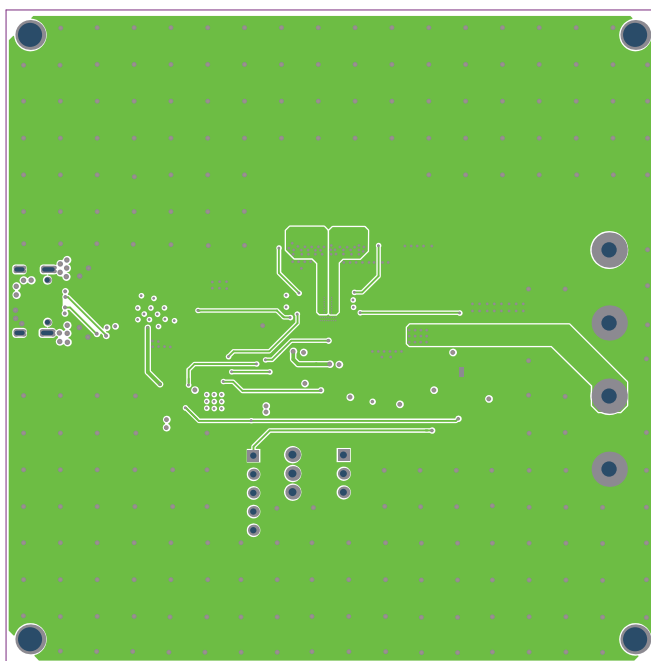

Figure 6: Mid-Layer 2

PCB LAYOUT (continued)

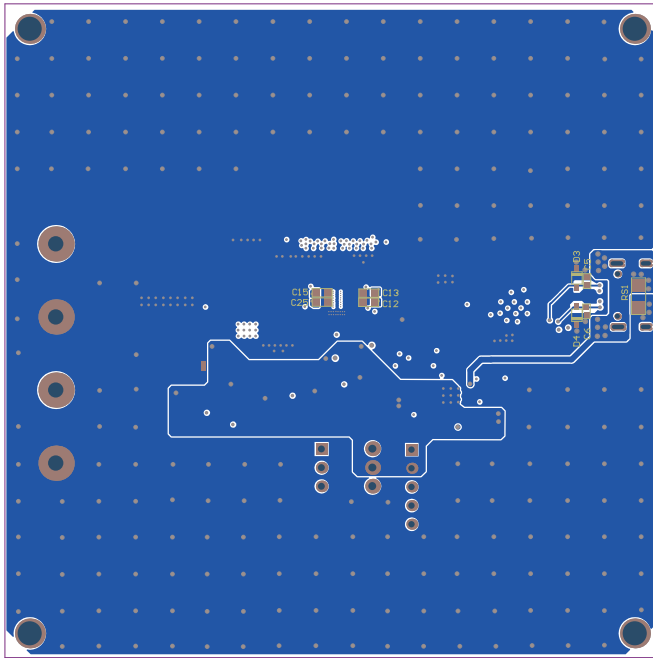

Figure 7: Bottom Layer

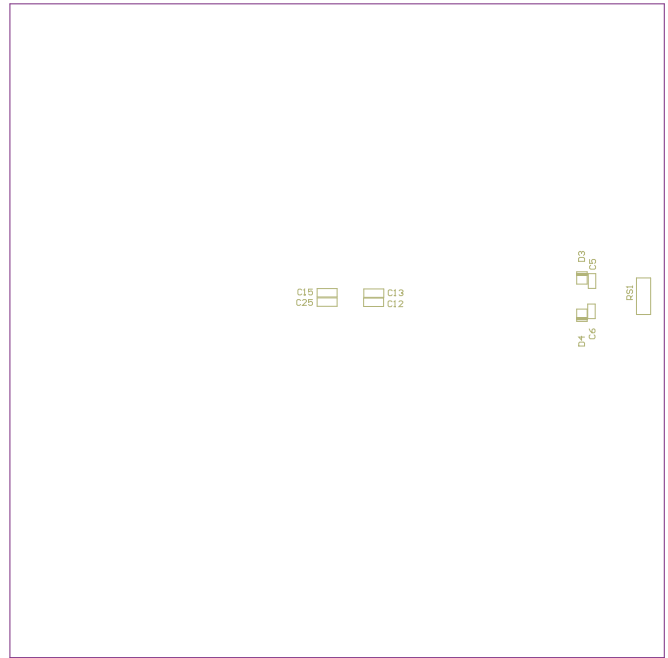

Figure 8: Bottom Silk



REVISION HISTORY

Revision #	Revision Date	Description	Pages Updated
1.0	4/4/2022	Initial Release	-

Notice: The information in this document is subject to change without notice. Please contact MPS for current specifications. Users should warrant and guarantee that third-party Intellectual Property rights are not infringed upon when integrating MPS products into any application. MPS will not assume any legal responsibility for any said applications.