

From Prototyping to Production

Modules Accelerate the Power Design Process

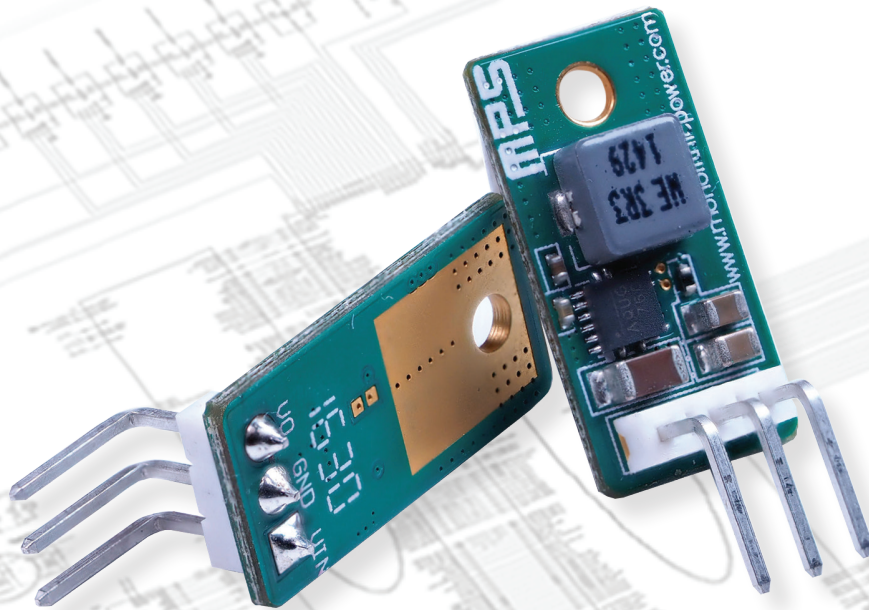

MPS[®]
Monolithic Power Systems

Change is Here

The electronics industry is evolving and these changes are having a **big** effect on the power design market.

The electronics industry is evolving and these changes are having a big effect on the power design market. Design engineers are now seeing how modules can provide benefits over traditional discrete designs.

Modules from Monolithic Power Solutions (MPS) can further add to the competitive advantages of power modules, such as ease of design, cost effectiveness, efficiency and size, with the additional benefits of higher performance from the company's own market-leading ICs, higher modular integration leading to easier PCB layouts, and drop-in solutions that require no design work.



Contents

All Change for Power Designers

4-6

Power Modules

7

MPS

8

MPM Power Modules

9 - 10

Taking Modules to the Next Level - the mEZ Range

12 - 15

Summary

16

Contact

17

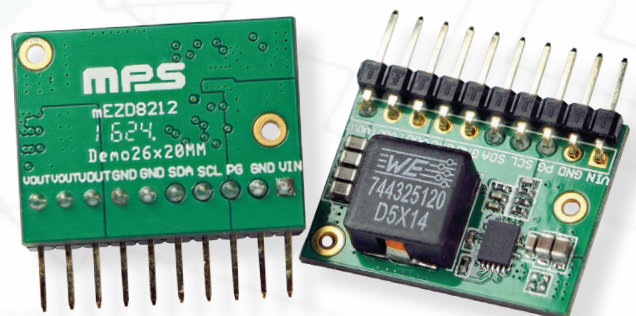

All Change for Power Designers

Power design has often been almost an afterthought to designers of electronic products. Designers would often design the rest of the product, and then at the last minute calculate the power requirements and quickly design a product to suit those specifications. Often, this improvised design would simply be a slight adaptation of the power supply from a previous generation of products. Designs like these were large, inefficient and wasteful, but they normally could be made to power the product with some work.

Industry Change

Now, the whole industry has changed, and this type of design is no longer possible for a number of reasons. The first reason is time. Designers are under increasing pressure to get products to market. There is just not the time available to develop various iterations of a design until it works. Today's designs must work the first time and be able to rapidly move from prototype to volume production.

Battery Restrictions

Modern products often rely on batteries for power, and this also has changed the design environment. Power efficiency has quickly become the single-most important consideration for portable devices, like cell phones, as users demand longer battery life. Battery-powered devices also are often restricted by size limitations, as users have come to expect a small, ergonomic solution.

Power design has often been almost an afterthought to designers of electronic products.

There has also been a shortage of engineers that specialize in power design.

Today's Market

There is no room for products that have large PCBs, which are wasteful of space. Even if users weren't demanding more efficient products, legislation, such as Energy Star in the US and ErP in Europe, now mandates energy-efficient designs, along with other constraining factors, such as limits on standby power. As utility costs have increased, this focus on energy efficiency has now moved beyond battery-powered devices into all electrical products. For products to meet efficiency standards requires additional design time, testing, and certification. A pre-certified solution would enable products to meet these standards and get to market more quickly.

Components Matter

There is also a change in the components we use. Today's ICs have become much more complex, and the power supplies they need to operate have become just as complex. Older microprocessors and field programmable gate arrays (FPGAs) only required a single voltage level. Today's peripheral-rich ICs can have many different voltage requirements, along with the need for precise slew rates and boot-up sequences.

Another advance that has affected the industry over the last decade is a move towards distributed power supplies. Taking the final voltage conversion closer to the point-of-load provides a much higher rate of efficiency than converting remotely and suffering transmission losses. These losses would be magnified if the system needs multiple, different supply rails.

These changes in power requirements have developed over the same period of time, making many design practices obsolete. In the future, these trends are set to continue or even accelerate, and demands on power supplies will only continue to increase in complexity. There has also been a shortage of engineers that specialize in power design. Since the global downturn in 2008, companies have struggled to recruit experienced engineering staff, so the engineers that they do have are required to cover multiple disciplines, rather than specialize.

All Change for Power Designers

Saving Space

Traditionally, designers would sit down and build the design using discrete components, but that method is no longer effective for the vast majority of designs. A component or circuit with a single voltage rail would require a relatively simple circuit, which could easily be designed using discrete components. However, a circuit that requires five different voltage rails will require five separate circuits, each one increasing the size of the solution and increasing the Bill of Materials. In today's market, products just don't have the room for a sprawling power supply design with many redundant components.

Time Crunch

The rush to get new products to market means that there is no longer time for lengthy redesigns. If features are added or dropped during the design cycle, a power designer using discrete products would normally have to restart the whole design process from the beginning, which could delay the product release date.

Design Flexibility

To keep up with the increasing pace of innovation, power designers need a way to change designs as easily as the embedded designer, who can drop in a more powerful microcontroller that is from the same family and has the same pin layout. Other designers would benefit from an easy way of prototyping the power design until the final specifications are set and then creating a custom design using the same components.

In today's market, products just don't have the room for a sprawling power supply design with many redundant components.

Power Modules

One way that manufacturers have attempted to help designers is by integrating the main power components into a single package. This technique offers many advantages to designers of power systems.

Integration

Designs based on modules are quicker to design into a product. They are smaller than discrete designs and they are also generally available in industry standard packaging, meaning that if the design changes, then a different module from the same range can be chosen and easily dropped into the design.

For easier design-in, many modules not only comply with efficiencies mandated by international standards bodies, they also provide the capability to easily comply with standards for individual industries.

One big step forward for power manufacturers was when they could increase the speed of switching to a rate that shrunk inductors enough to be incorporated in modules. However, using higher switching frequencies often leads to problems with EMI/RFI. Most modules are manufactured to minimize these effects. Over time, the amount of components that can be integrated into modules has increased, until, in many occasions, the only external components are passives that are

The majority of manufacturers of power products now offer ranges of modules that enable quicker power designs. But, as in all other areas, not all things are equal.

deliberately left out to allow designers some flexibility in the design. Modules can also be easily used together in a single design to provide a higher current output or provide extra voltage rails.

The majority of manufacturers of power products now offer ranges of modules that enable quicker power designs. But, as in all other areas, not all things are equal. There can be a wide variety of differences in size, efficiency, and heat dissipation, as well as the design-in time required. Even though the modules are intended to do the same job, their attributes can vary considerably.

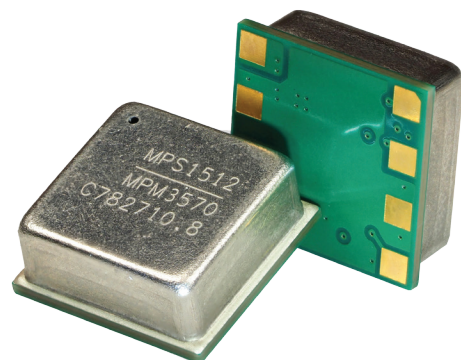

MPS is one company that has led the field in power module design, especially in the medical and industrial markets.

Over the last two decades, MPS has been designing innovative products that are powerful and easy to use. These products have been integrated into the designs of some of the world's largest and most innovative companies. The company now has two distinct ranges of modules that lead the market in their respective areas.

Best-in-Class

The main reasons for this lead are the proprietary technology MPS uses to manufacture its modules, and a focus on only using best-in-class components. Both the MPM and mEZ ranges use monolithic integrated circuits with power transistors and control circuitry integrated on a single chip using an advanced BCD (Bipolar – CMOS – DMOS) manufacturing process. This allows higher frequency switching and higher efficiency. Competitors typically package separate power FET controller die together inside the module.

The MPS process also produces a smaller die, which combined with a high switching rate that allows smaller inductors, enables the device to be enclosed in a small QFN package instead of the BGA packaging used by competitors. It is not only the size of the device, QFN packages are easier to solder on the production line, and allow easier rework, ensuring a higher PCB yield. The devices can be easily inspected without the expensive equipment that a BGA solution would require.

The module is manufactured using a single lead-frame, which integrates all the required components, including inductors, passives, and MPS' own industry leading regulator ICs. The modules are then produced using standard IC assembly processes. Eliminating extra process steps and integrating ICs developed in-house also has the benefit of making the module more reliable and cost-effective than modules that use multi-step techniques.

MPM Power Modules with Integrated Inductors

MPS power modules adhere to the philosophy that has made the company's previous power products so successful. The company has always focused on releasing products that offer the highest performance in a format that is easy to design into any solution.

Ease of Design

MPS

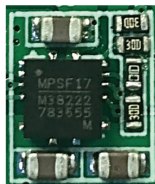
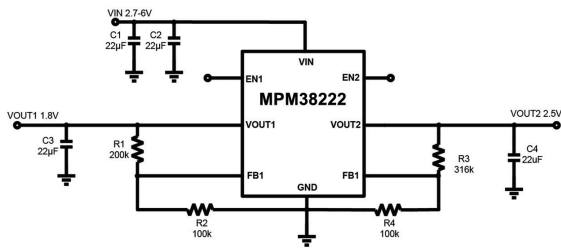

Competitor

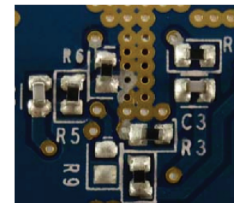
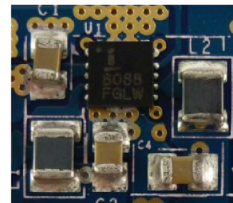
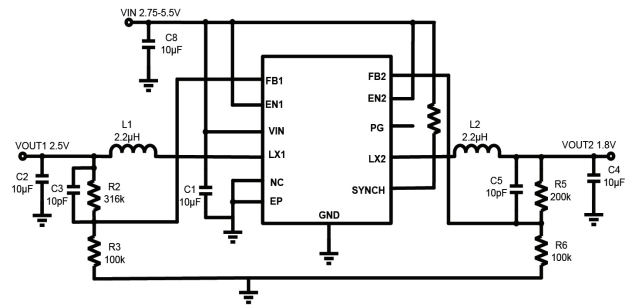

High Performance - MPS' MPM38222

Efficiency vs. Load Current

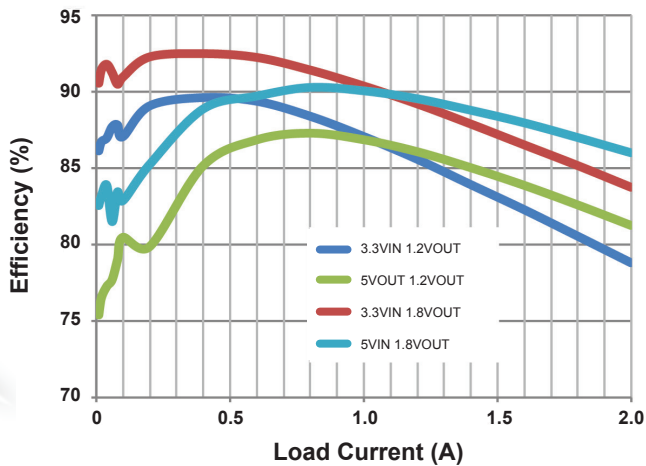

Output Voltage Ripple

$$V_{IN} = 5V, V_{OUT}/2A$$

$$CH1=1.8, CH2=1.2V/2A$$

$$C_{OUT1}=C_{OUT2}=22 \mu F$$

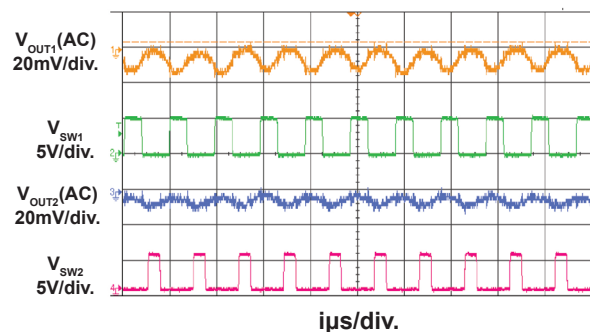

MPM Power Modules with Integrated Inductors

Simple Assembly Process

MPS' philosophy also caters for simple manufacturing without requiring specialized or expensive equipment. The modules integrate the maximum number of components, including the inductor, while still providing comprehensive flexibility for the designer to tailor the device's attributes.

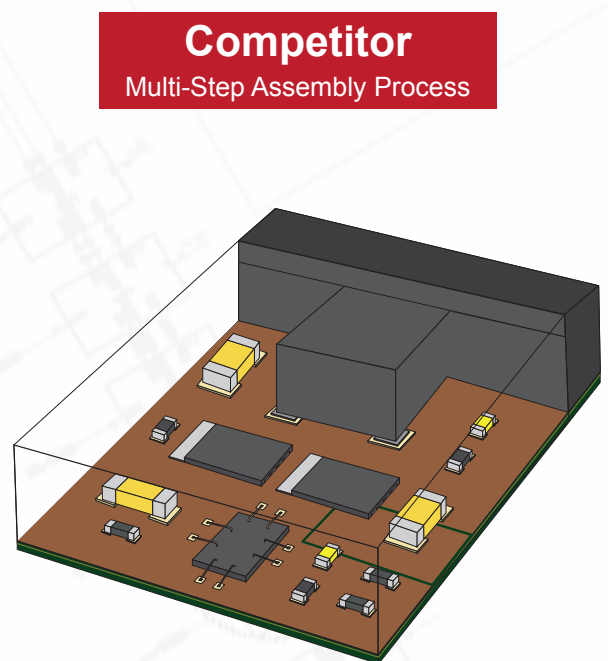
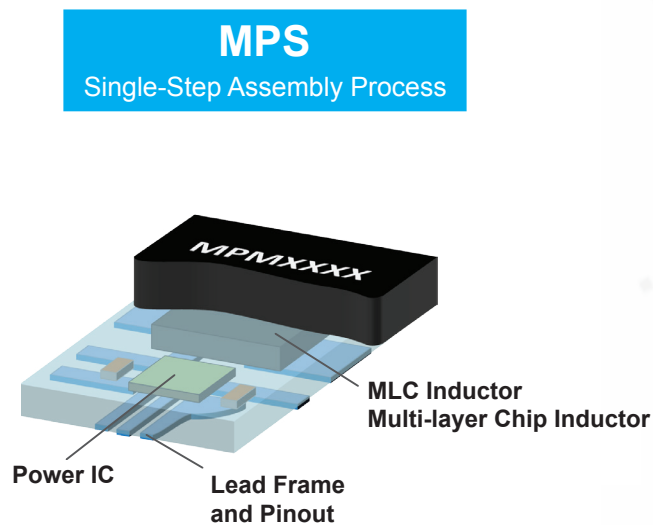

MPM modules integrate the maximum number of components, including the inductor, while still providing comprehensive flexibility for the designer to tailor the device's attributes.

IOUT \ VIN	VIN		
	5.5V	18V	36V
0.6A	MPM3805 MPM3804	MPM3606 MPM3606A	MPM3506A
1.2A	MPM3810 MPM38111	MPM3610 MPM3610A	MPM3510A
1.5A			MPM3515
2A	MPM3820 MPM38222	MPM3620 MPM3620A	
3A	MPM3830	MPM3630	
4A	MPM3840		
6A	MPM3680		
10A	MPM3682 MPM3695-10		
15A	MPM3684		
20A	MPM3686		
25A	MPM3695-25		

Taking Modules to the Next Level - the mEZ Range

mEZ products provide **3-5%** higher efficiency and up to **40%** reduced package size.

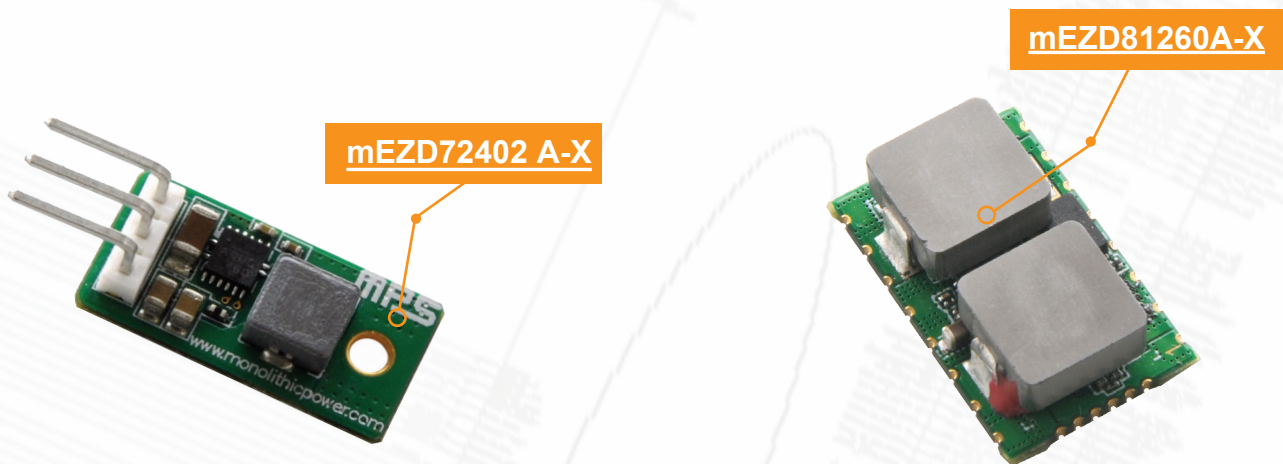

Design Flexibility

Although modules offer an easy method of integrating a total power solution into a product, they still require a little design work, both to get the exact specifications required and to implement the solutions onto the PCB. Some manufacturers would prefer an even easier entry point with no design work whatsoever. MPS has created the mEZ series for those times. Containing every component required for a complete power solution, the modules are plug and play, allowing the designer to simply drop the module into the design.

Although the modules contain all the components for a full solution, the attributes of the module are able to be programmed digitally to give a range of configurability options, including for switching frequency, switching compensation, and slew rate. mEZ products provide 3-5% higher efficiency and up to 40% reduced package size. The scalable and versatile range has options for buck and boost DC/DC converters, PoE, and USB charger applications.

Up to 3-5% Higher Efficiency

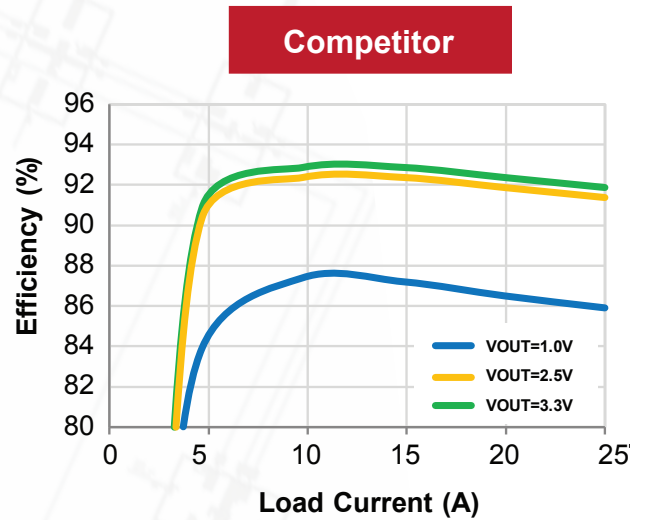
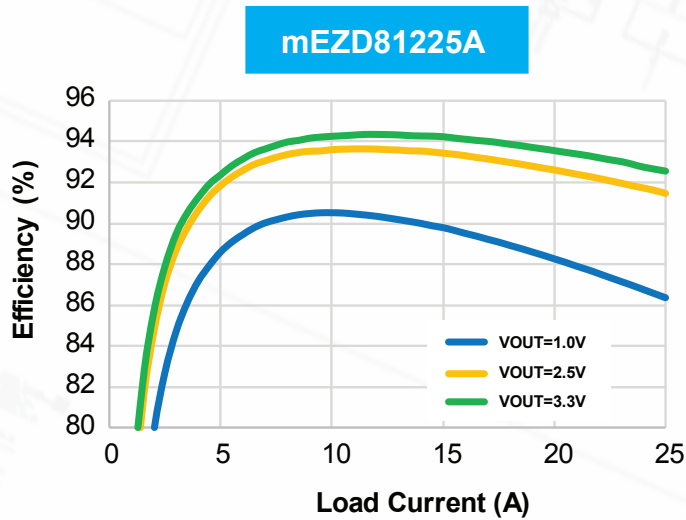

Reduces Solution Size by up to 40%

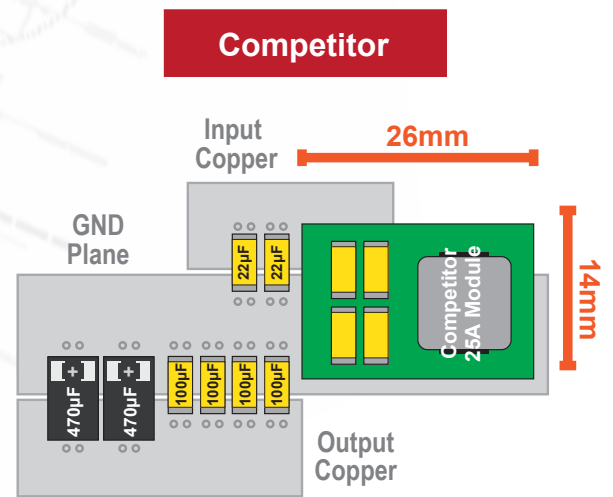
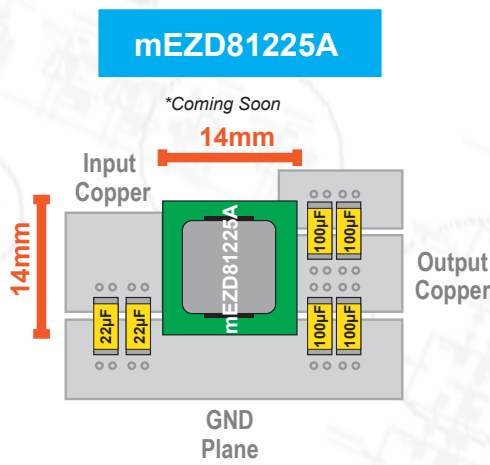

*Comparison shows top side of solutions

Taking Modules to the Next Level - the mEZ Range

mEZ modules include a full Bill of Materials for manufacturing yourself when transitioning from design to mass production.

Plug & Play

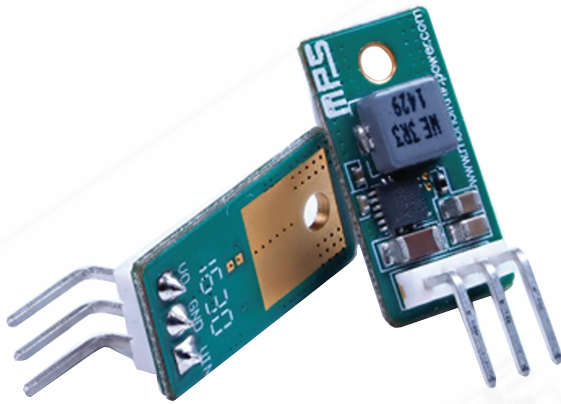

Manufacture Yourself

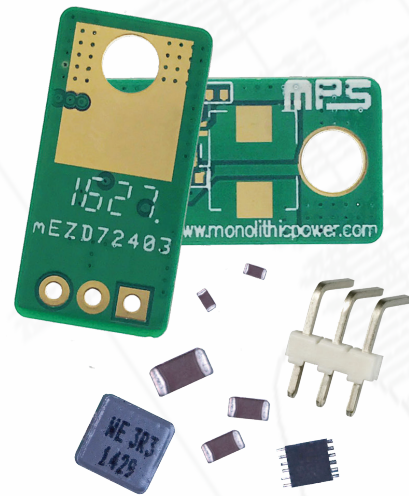

From Prototyping to Mass Production

mEZ modules allow designers of low-volume products, who are usually focused on easy development and getting a product to market quickly rather than on single-unit cost, to employ the same module from the prototyping phase right through to production, saving on design time by just plugging in a complete power design.

Designers of high-volume products can also benefit from mEZ modules by using them as the power board on a prototype design. Once the final specification is set and the prototype is built and working, the designer can use the same components from the module in a smaller, more economical PCB design. This provides a solution with an ideal combination of fast prototyping, low board real estate, and minimized costs for mass production.

mEZ Step-Down Product Family

The step-down products offer wide input voltage operation ranges between 4.5V and 36V, with 1A-3A output current.

VIN \ IOUT	IOUT					
	≤1A	2A	3A	10A	25A	Dual 30A/ Single 60A
48V	mEZD74800A-x					
24V	mEZD72401A-x	mEZD72402A-x				
12V	mEZD71201A-x	mEZD71202A-x	mEZD71203A-x	mEZD71210A-x	mEZD81225A	mEZD81260A*

*Coming Soon

[Click on any solution for more information](#)

mEZ Step-Up Product Family

The step-up products offer wide input voltage operation ranges between 2.7V and 13V, with 1A to 3A output current.

VIN \ IOUT	IOUT		
	≤1A	2A	3A
15V	mEZD41501A-x	mEZD41502A-x	
12V			mEZD41503A-B
5V			

[Click on any solution for more information](#)

Special Functions

Other options include a 36V/2.5A complete USB charger and 48V/13W complete PoE solution.

mEzS84801A PoE Supply IEEE 802.3 af Compliant	mEzS91202A 36V Input 2.5A USB Charger
--	--

[Click on any solution for more information](#)

Summary

MPS modules are unique in that the company uses a single-step process to manufacture the modules, which provides an even more distinct leap in cost-effectiveness, efficiency, performance, size and EMI/RFI handling over both discrete designs and competitors' modules.

For quite some time, there was a debate over whether modules or discrete solutions were best for power supply design. The way the industry has evolved means that the debate is mainly over – modules offer a better choice for the vast majority of applications, and especially for all of the main metrics such as design time, efficiency, and size.

MPS modules are unique in that the company uses a single-step process to manufacture the modules, which provides an even more distinct leap in cost-effectiveness, efficiency, performance, size and EMI/RFI handling over both discrete designs and competitors' modules.

Both the MPM and the mEZ ranges of products are designed to be easily incorporated into any design and go through the manufacturing process without using any specialized, expensive production and test equipment. The mEZ range is especially flexible, and can be used as proof of concept in the prototyping phase with MPS ICs used in the final design.

Whatever your power requirements, there is an MPS module available for almost every application, which will provide an easy design-in and market leading performance. These modules are designed to ease the growing challenges for power supply designers and ensure a future-proof solution.

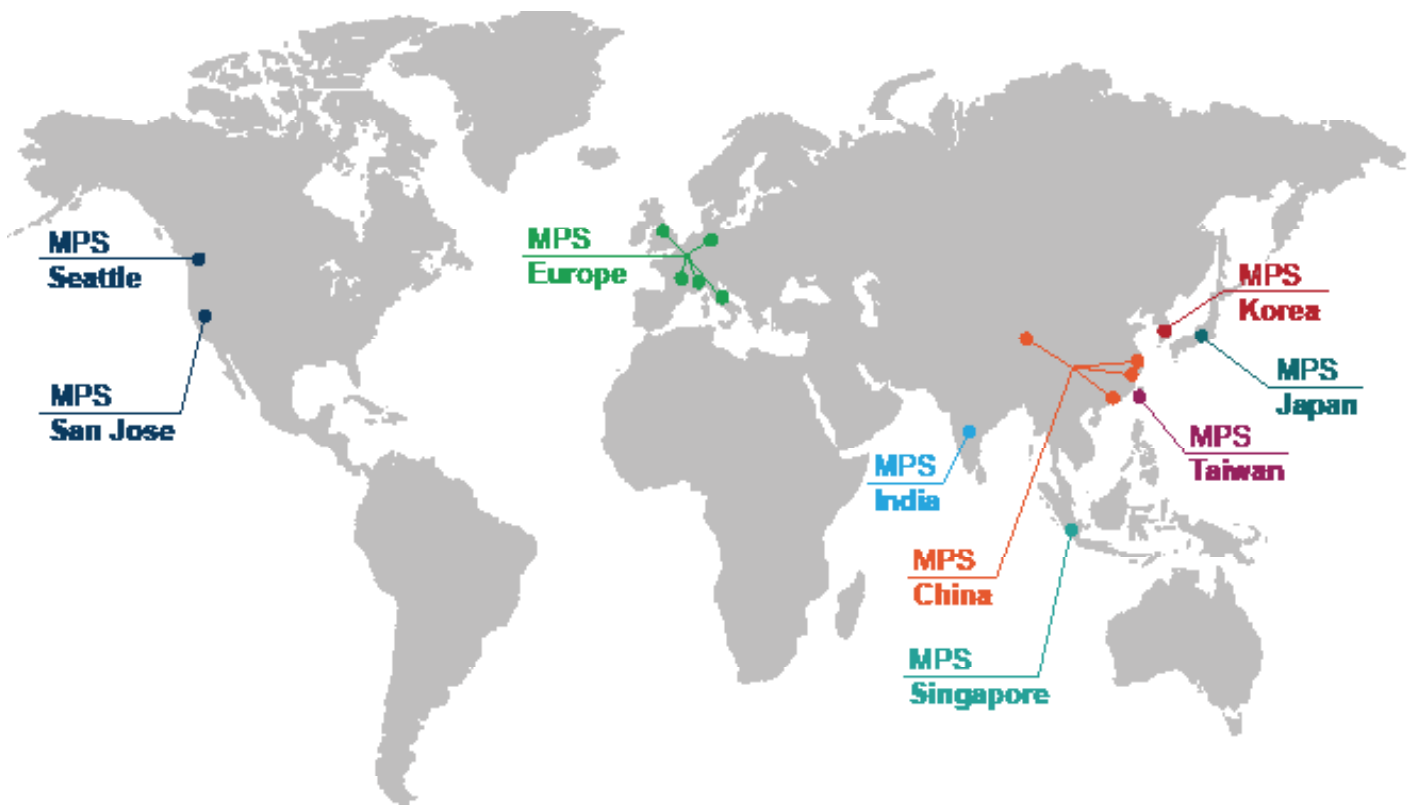

Need products, design tools, or support?

We're here to help. Click on any link below for more information.

[Sales Offices & Distributors](#)

[General Support](#)

[Tools, Evaluation Boards, and Design Support](#)

[Product Info](#)

From Prototyping to Production

Modules Accelerate the Power Design Process

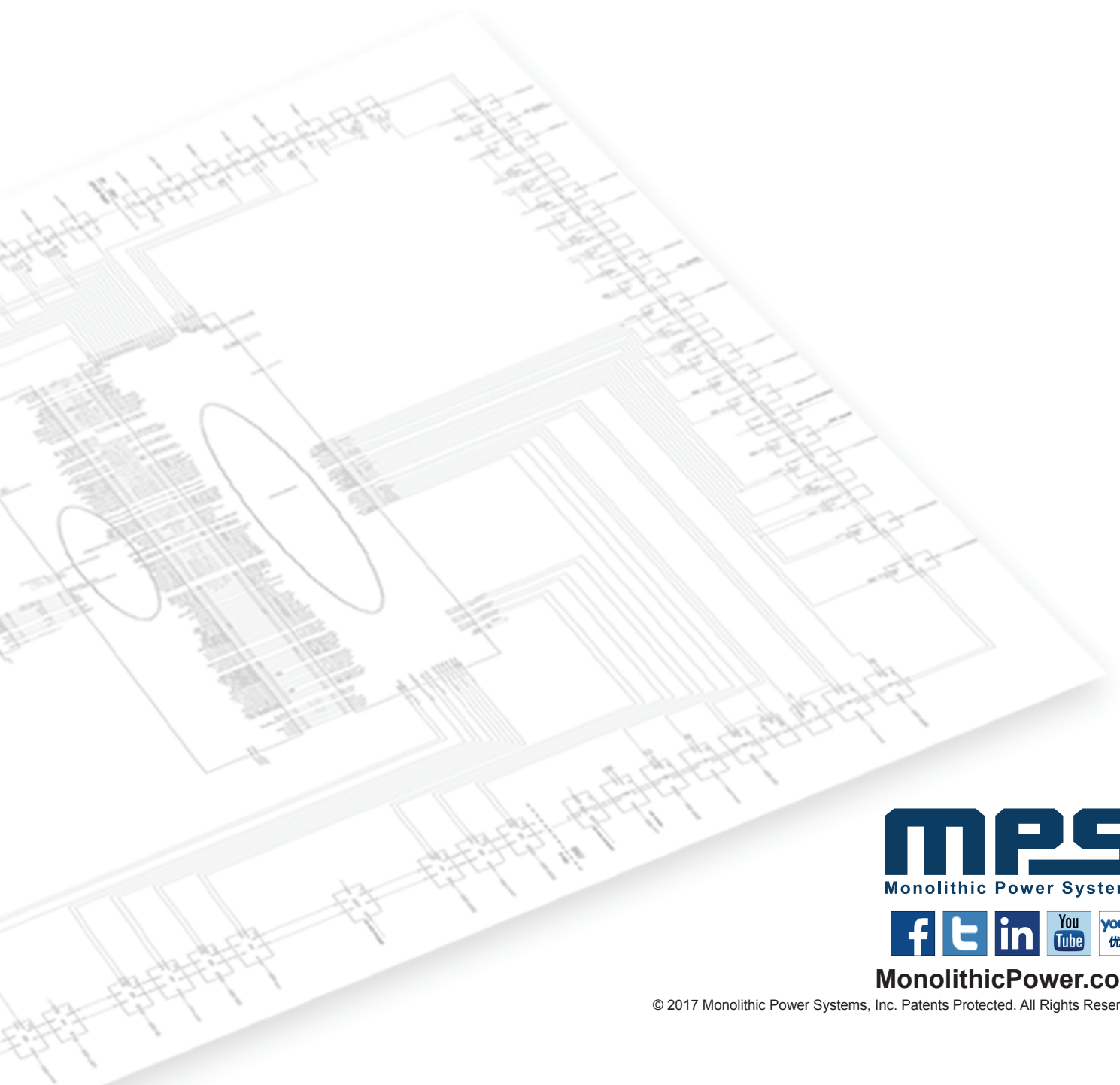

MPS[®]
Monolithic Power Systems



MonolithicPower.com

© 2017 Monolithic Power Systems, Inc. Patents Protected. All Rights Reserved.